

ATR

National Scientific User Facility



2011

Annual Report

Todd Allen
Scientific Director
(608) 265-4083
allen@enr.wisc.edu

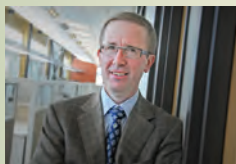

Frances Marshall
Manager, Program Operations
(208) 526-8947
frances.marshall@inl.gov



ATR NSUF Contact Information

Jeff Benson
Education Coordinator
(208) 526-3841
jeff.benson@inl.gov



Jim Cole
Chief Scientist
(208) 526-8101
james.cole@inl.gov



John Jackson
Industry Program Lead
(208) 526-0293
john.jackson@inl.gov



Collin Knight
Project Manager
Post-irradiation Examination
(208) 533-7707
collin.knight@inl.gov



Dan Ogden
Project Manager
Irradiation Experiments
(208) 526-4400
dan.ogden@inl.gov



Renae Soelberg
Administrative Assistant
(208) 526-6918
renae.soelberg@inl.gov



Mary Catherine Thelen
Program Administrator
(208) 526-5209
mary.thelen@inl.gov



Julie Ulrich
Communication Liaison
(208) 533-4167
julie.ulrich@inl.gov



Participants of the
2011 Users Week

Advanced Test Reactor National Scientific User Facility

2011 Annual Report

Todd Allen, Scientific Director
Mary Catherine Thelen, Editor

June 2012

(This report covers the period beginning October 1, 2010, through September 30, 2011.)

ATR National Scientific User Facility
995 University Boulevard
Idaho Falls, ID 83401-3553

For the most up-to-date information, visit the ATR NSUF website at <http://www.atrnsl.gov>.
A copy of this report is available in PDF format at <http://www.atrnsl.gov>.

Disclaimer

This report was prepared as an account of work sponsored by an agency of the United States Government. Neither the United States Government nor any agency thereof, nor any of their employees, makes any warranty, expressed or implied, or assumes any legal liability or responsibility for the accuracy, completeness, or usefulness of any information, apparatus, product, or process disclosed, or represents that its use would not infringe privately owned rights. References herein to any specific commercial product, process, or service by trade name, trade mark, manufacturer, or otherwise, does not necessarily constitute or imply its endorsement, recommendation, or favoring by the U.S. Government or any agency thereof. The views and opinions of authors expressed herein do not necessarily state or reflect those of the U.S. Government or any agency thereof.

INL/EXT 12-25810

Prepared for the U.S. Department of Energy, Office of Nuclear Energy under DOE Idaho Operations Office Contract DE-AC07-051D14517.

Table of Contents

	Welcome & Introduction	1
	Principal Investigators Set the Pace.....	3-8
	Students – The Next Wave of Knowledge.....	9-12
	ATR NSUF Partners – The Energy of Collaboration.....	13
	Illinois Institute of Technology – Continuing a History of Nuclear Research	15
	Massachusetts Institute of Technology – Meeting the World’s Great Challenges	17
	North Carolina State University – A Unique Facility Builds on a Proud History.....	19
	Oak Ridge National Laboratory – Appalachian Atoms	21
	University of California, Berkeley – “City of Learning” Continues Tradition.....	23
	University of Michigan – Progress through Partnerships	25
	University of Nevada, Las Vegas – Rebel School Advances Nuclear Science.....	27
	University of Wisconsin – Scientific Excellence in Action.....	29
	ATR NSUF Program Information.....	31
	Program Overview	33
	Reactor Capabilities	35
	Post-irradiation Examination Capabilities	37
	Beamline Capabilities	39
	Calls for Proposals	41
	Users Week	43
	Educational Programs and Opportunities	45
	Distributed Partnership at a Glance	47
	Awarded Projects Reports	
	Irradiation Effect on Thermophysical Properties of Hafnium-Aluminide Composite: A Concept for Fast Neutron Testing at the Advanced Test Reactor.....	49
	Principal Investigator: Heng Ban – Utah State University (e-mail: Heng.ban@usu.edu)	
	Advanced Damage-Tolerant Ceramics: Candidates for Nuclear Structural Applications.....	51
	Principal Investigator: Michel Barsoum – Drexel University(e-mail: barsoum@drexel.edu)	
	Development and Validation of an Advanced Test Reactor Critical Radiation Transport Model	53
	Principal Investigator: Denis Beller – University of Nevada, Las Vegas (e-mail: bellerd@unlv.nevada.edu)	
	Developing a Mechanistic Understanding of Radiation Tolerant Materials	55
	Principal Investigator: David T. Hoelzer – Oak Ridge National Laboratory (e-mail: hoelzerd@ornl.gov)	

Real-Time Advanced Test Reactor Critical Facility (ATRC) Flux Sensors.....	57
Principal Investigators: George Imel and Jason Harris – Idaho State University(e-mail: gimel@isu.edu)	
Measurement of Actinide Neutronic Transmutation Rates with Accelerator Mass Spectroscopy (MANTRA).....	61
Principal Investigator: George Imel – Idaho State University (e-mail: gimel@isu.edu)	
Irradiation and Examination Program for Triplex SiC Composite Tubing for PWR Fuel Cladding Applications.....	63
Principal Investigator: Mujid S. Kazimi – Massachusetts Institute of Technology (e-mail: kazimi@mit.edu)	
Synchrotron X-ray Diffraction Study of Microstructural Evolution in Irradiated Mod.9Cr-1 Mo Steel	67
Principal Investigator: Meimei Li – Argonne National Laboratory (e-mail: mli@anl.gov)	
Atomic Scale Analysis of Oxide Dispersion Strengthened Steels Before and After High Dose Ion Implantation	69
Principal Investigator: Emmanuelle Marquis – University of Michigan (e-mail: emarq@umich.edu)	
Influence of Fast Neutron Irradiation on the Mechanical Properties and Microstructure of Nanostructured Metals/Alloys	71
Principal Investigator: K.L. Murty – North Carolina State University (e-mail: murty@eos.ncsu.edu)	
Irradiation of Potential Inert Matrix Materials.....	73
Principal Investigator: Juan C. Nino – University of Florida (e-mail: jnino@mse.ufl.edu)	
Characterization of Advanced Structural Alloys for Radiation Service	77
Principal Investigator: G. R. Odette – University of California, Santa Barbara (e-mail: Odette@engineering.ucsb.edu)	
A High Fluence Embrittlement Database and ATR Irradiation Facility for Light Water Reactor Vessel Life Extension	79
Principal Investigator: G.R. Odette – University of California, Santa Barbara (e-mail: Odette@engineering.ucsb.edu)	
Light Water Reactor Hydride Fuel Irradiation Experiment.....	81
Principal Investigators: Donald R. Olander and Mehdi Balooch – University of California, Berkeley (e-mail: fuelpr@nuc.berkeley.edu)	
Radiation Stability and Integrity of Amorphous Metal Alloys for Applications in Harsh Environments Principal Investigator: Lin Shao – Texas A & M University (e-mail: lshao@ne.tamu.edu)	83
University of Wisconsin Pilot Project at the Advanced Test Reactor National Scientific User Facility.....	85
Principal Investigator: Kumar Sridharan - University of Wisconsin (e-mail: kumar@enr.wisc.edu)	
Irradiation Performance of Iron-Chromium (Fe-Cr) Base Alloys	89
Principal Investigator: James F. Stubbins – University of Illinois (e-mail: jstubbin@illinois.edu)	
Microstructural and Irradiation Effects on Silver (Ag) and Cesium (Cs) Diffusion in CVD-Silicon-Carbide (SiC).....	91
Principal Investigator: Izabela Szlufarska – University of Wisconsin (e-mail: szlufarska@wisc.edu)	
Corrosion Test in Supercritical Water for Nitride-based Coatings on Light Water Reactor Cladding	93
Principal Investigator: Haiyan Wang – Texas A&M University (e-mail: wangh@ece.tamu.edu)	
Radiation Stability of Ceramics for Advanced Fuel Applications.....	95
Principal Investigator: Yong Yang – University of Wisconsin, currently located at the University of Florida (e-mail: yongyang@ufl.edu)	

Acronym List



ANL.....	Argonne National Laboratory
APS	Advanced Photon Source
APT.....	Atom Probe Tomography
ATR.....	Advanced Test Reactor
ATRC.....	Advanced Test Reactor Critical
BWR	Boiling Water Reactor
CAES.....	Center for Advanced Energy Studies
CEA	Commissariat à l'énergie atomique
DOE.....	Department of Energy
EML	Electron Microscopy Laboratory
FIB.....	Focused Ion Beam
FSRT	Facility/Student Research Team
HFEF	Hot Fuel Examination Facility
HFIR	High Flux Isotope Reactor
INL.....	Idaho National Laboratory
IIT	Illinois Institute of Technology
IMC.....	Irradiated Materials Complex
IFEL.....	Irradiated Fuels Examination Laboratory
IMET	Irradiated Materials Examination and Testing Facility
ISU.....	Idaho State University
ITER	International Thermonuclear Experimental Reactor
LEAP	Local Electron Atom Probe
LANL.....	Los Alamos National Laboratory
LWR.....	Light Water Reactor
MaCS.....	Microscopy and Characterization Suite
MFC.....	Materials and Fuels Complex
MIBL	Michigan Ion Beam Laboratory

MIT	Massachusetts Institute of Technology
MITR.....	Massachusetts Institute of Technology Reactor
MRCAT	Materials Research Collaborative Access Team
NCSU	North Carolina State University
NE.....	Nuclear Energy
NIST	National Institute of Standards and Technology
ODS.....	Oxide Dispersion Strengthened
ORNL.....	Oak Ridge National Laboratory
PI	Principal Investigator
PNNL	Pacific Northwest National Laboratory
PWR	Pressurized Water Reactor
REDC	Radiochemical Engineering Development Center
SANS.....	Small Angle Neutron Scattering
SEM.....	Scanning Electron Microscopy
EM.....	Transmission Electron Microscopy
TMS.....	The Minerals, Metals, & Materials Society
UCB.....	University of California, Berkeley
UCSB.....	University of California, Santa Barbara
UM.....	University of Michigan
UNLV	University of Nevada, Las Vegas
USU	Utah Sate University
UW.....	University of Wisconsin
XAS	X-ray Absorption Spectroscopy
XRD	X-ray Diffraction

Welcome & Introduction

Dr. Todd Allen
ATR NSUF Scientific Director
and
Professor of
Engineering Physics,
University of Wisconsin



It is always my pleasure to introduce the Advanced Test Reactor (ATR) National Scientific User Facility (NSUF) annual report, and this one is no exception. 2011 was a year of growth for the User Facility, and this report highlights not only the interesting research that was accomplished, but also the variety of facilities and people involved in making ATR NSUF a successful national and international model.

In 2011, we engaged more of our partners than the previous fiscal year, and it was exciting to see these collaborations evolve and to witness the enthusiasm of both our partners and the researchers who used these facilities. 2011 research awards to partner facilities included: University of Michigan Ion Beam Laboratory; North Carolina State's PULSTAR reactor; Illinois Institute of Technology's Materials Research Collaborative Access Team (MRCAT) at the Advanced Photon Source (APS); Harry Reid Center's Radiochemistry Laboratory at University of Nevada, Las Vegas; and several experiments that utilized the Microscopy and Characterization Suite at the Center for Advanced Energy Studies in Idaho Falls. Research also continued for experiments that were started in the previous fiscal year at the MIT reactor.

In addition to engaging more of our existing partners, we added two new partners to our program in 2011, bringing

the total to eight ATR NSUF partners. New facilities/capabilities added included the High Flux Isotope Reactor (HFIR) and several hot cell facilities at Oak Ridge National Laboratory (ORNL), and several post-irradiation examination instruments from the Nuclear Materials Laboratory at the University of California, Berkeley. I am always excited to add new partners because it convinces me of the value of creating this distributed network of capabilities. The fact that we were able to engage so many partners this past year also shows that the capabilities added by our partners are not only useful to the research community but in fact enable needed research for which there was no vehicle. Our partners are so integral to what we do, that for this report we interviewed the lead for each facility so that you could learn not only about their capabilities, but a bit about the institutions themselves. The results make for some interesting reading and even I learned a thing or two along the way.

In addition to two new partners, ATR NSUF added a new Idaho National Laboratory (INL) capability to our growing suite of capabilities. While this addition benefits the entire INL, we had the opportunity to be the first organization within the laboratory to utilize it. I'm talking here about the hydraulic shuttle irradiation system (HSIS), or "rabbit," in the Advanced Test Reactor. The main advantage of the

“rabbit” is it allows researchers to do short-term irradiation experiments while the reactor is operating, or in other words, we don’t have to wait for a reactor shutdown to add an experiment. This means that irradiation periods can be tailored to meet experiment specifications for very low-dose irradiations. The first experiment to utilize the “rabbit” was a subsection of a large ATR NSUF irradiation experiment awarded to the University of Illinois (UI) in 2008. This pilot “rabbit” experiment was performed in two phases over the course of several weeks. While the results have not yet been analyzed, we believe this new capability will be of value to researchers who require very specific low fluences for their experiments.

In 2011 we hosted the largest Users Week since our inception. With more than 160 participants, it was a great opportunity for both learning and forming new collaborations. This event drew students, faculty, and top industry and national laboratory researchers from 32 universities, various DOE laboratories, and private industry. The annual Users Week typically offers researchers a first-hand look at the unique nuclear research facilities the INL brings to the ATR NSUF. The 2011 week was a bit different from past Users Weeks in that it was also a joint meeting with the DOE Basic Energy Sciences sponsored Center for Materials Science and Nuclear Fuels Summer School. By making this a joint meeting, we brought together an even wider group of researchers than a typical Users Week would, and were able to introduce them to the concept of what the ATR NSUF offers.

Another highlight of Users Week was the poster session. For the first time since its inception we were able to offer cash prizes to the students of the top three posters. This was actually a two-fold success because it was a great opportunity to encourage students to submit posters, but it was also a success for the newly formed ATR NSUF User Organization which took the challenge of finding the sponsors for, and hosting the poster session. This was one of the first tasks our User Organization undertook, and it was a big success and one it plans to continue in future Users Weeks.

And speaking of our User Organization, it was formally organized in 2011, an executive committee was elected and a charter was drafted and finalized—yet another great accomplishment for ATR NSUF. The User Organization was formed to provide a formal channel for the exchange of information, advice and best practices between the researchers who perform experiments and the ATR NSUF

management. The current chair of the executive committee is Dr. Jeff Terry from Illinois Institute of Technology (also one of our partner facilities); the Secretary is Dr. Dave Senor of Pacific Northwest National Laboratory; the student member is Dr. Peng Xu, formerly of the University of Wisconsin, but now of Westinghouse; and the general members are Dr. Denis Beller of University of Nevada, Las Vegas; Dr. K. L. Murty of North Carolina State University; and Dr. Sean McDevitt of Texas A&M University. We are extremely pleased to have a User Organization and look forward to working together to achieve the goals of nuclear energy research.

Not everything was a success in 2011—we faced some challenges too. Budget realities meant awarding fewer large irradiation projects than in past years, so we pushed hard to expand the number of experimenters using the Rapid Turnaround Experiment process. Navigating the many procedures at the Materials and Fuels Complex (MFC) as we increased the number of samples analyzed using that facility proved arduous at times. The loss and replacement of key staff meant some slow-down in momentum as people came up to speed in new positions. Each challenge was addressed and we welcomed some new faces and fresh ideas into ATR NSUF, and are working toward more efficient mechanisms for accomplishing work at MFC and finding creative and less expensive ways to accomplish research.

In all, it was another exciting, productive, and rewarding year. I hope you take the time to read through the entire report. Following this introduction are two articles describing the experiences of the professors and students of some of our first irradiation experiments. Their stories highlight not only the excitement of the research itself, but of the challenges ATR NSUF faces with each irradiation project. Following these stories we dedicated an entire section to our Partners who help make us a unique research model. There is also a section on the capabilities offered, and some information on our calls for proposals, Users Week and educational opportunities. Following the introductory information, is the heart of the report—the research section. This section contains a project report from each of our principal investigators who performed work in 2011.

That sums up the contents of this report. Thank you for your interest and continued support. Together we are creating something bigger than each facility could ever hope to create alone.

Principal Investigators Set the Pace

Introduction

When the Department of Energy (DOE), Office of Nuclear Energy (NE) decided in 2007 to make the ATR and post-irradiation examination facilities at the Idaho National Laboratory (INL) into a National Scientific User Facility, it was the start of a very good thing. Never before had universities been given the opportunity to irradiate materials with the kinds of flexibility the ATR offers, along with performing in-depth analysis on radioactive materials and fuels. This kind of testing would advance the state of knowledge for new fuels and materials for future reactors.

Since that time, the ATR NSUF has grown to include several additional reactors, and a host of examination capabilities as part of its Partnership Program, but in its humble beginnings, ATR NSUF offered researchers simply the chance to irradiate and examine fuels and materials at the INL facilities.

This story stems from those humble beginnings. In 2008 at the outset of ATR NSUF, it was determined that a pilot project was needed to learn the ins and outs of performing a university irradiation experiment in the ATR, and the challenges associated with the transfer of irradiated materials to MFC for analysis. Once the pilot was underway, the first call for proposals was issued, and from that call five proposals were selected for award.

Three of these first projects, including the pilot, are drawing to their conclusion. During the years between the award and completion of these three projects, much has been learned about how to run large, complicated experiments. The researchers who lead the way became some of the best ATR NSUF advocates. They were mavericks, and we thank them for their patience during our learning process, their enthusiasm as things came together, and their persistence in believing in the ATR NSUF program. Here are their tales as only they could tell them.



Dr. Kumar Sridharan is a distinguished research professor at the University of Wisconsin and a Fellow of the American Society for Materials. Sridharan's areas of expertise include nuclear reactor materials, corrosion, and surface modification of materials. He serves on the editorial boards of the *International Materials Reviews* and the *Journal of Materials Engineering and Performance*.

Sridharan was the university principal investigator (PI) for the pilot project—and so was the first to encounter and help iron out the technical and administrative hurdles that ATR NSUF would be faced with under its new mission. When asked why he accepted this project Sridharan answered, “As a materials scientist, I had not performed neutron irradiation experiments before, and because I was a non-nuclear engineer, I also felt I provided a solid test case for the INL staff. As it turned out, this was a great opportunity for me and a number of my students as well.”

Even though nuclear science and engineering had not been a previous focus for Sridharan, he was quick to understand the benefits of participating in the pilot.

“Nuclear energy currently provides nearly 15 percent of the world’s electricity needs, and the future demand for energy, and consequently for nuclear reactors, will increase rapidly. The need to understand degradation mechanisms in materials under the influence of neutron radiation will help us design new structural materials that improve reactor safety and efficiency.”

Through the pilot project Sridharan was able to irradiate several hundred different kinds of samples. This provided him the opportunity to meet a number of research goals.

“Given the wide variety of materials we’re studying, our project has several goals,” states Sridharan. “How would small compositional differences in steels of the same ‘nominal composition’ affect their irradiation responses? How would grain boundary orientations in the alloy affect radiation response? How would nanometers-scale oxide particles in the steel be affected by radiation? And would changes in temperature and radiation doses affect a material’s mechanical properties?” As the analyses unfold, he is getting answers to these questions.

Another benefit of the project, according to Sridharan, is that several Ph.D. students from the University of Wisconsin have been actively participating in the analyses. Nuclear materials was a topic of interest to these students, and because there was a variety of materials to choose from it was easy to find the right one to support their dissertations.

Not only have the students been participating using INL facilities, but through ATR NSUF Sridharan was able to utilize a number of other institutions with capabilities that would uniquely benefit the pilot. Some of these institutions had just become partners of ATR NSUF, and Sridharan was excited to be an early user of these facilities.

“The ATR NSUF partnership program has been crucially beneficial to our project. Our students, and in particular Alicia Certain and Kevin Field, were the first to use



UW graduate student Tyler Gerczak (center) demonstrates his sample analysis on scanning electron microscope to Kumar Sridharan (top) and Heather Chichester (bottom).

some of these facilities. Alicia used the University of Nevada, Las Vegas's state-of-the-art transmission electron microscope, and both Kevin and Alicia have prepared samples using focused ion beam (FIB) and transmission electron microscopy (TEM) at the Center for Advanced Energy Studies (CAES) Microscopy and Characterization Suite (MaCS) laboratory. According to Sridharan, "None of these research activities and their associated educational benefits would have been possible without the ATR NSUF's partnership program."

Sridharan also piloted several collaborations with institutions that are not yet part of the ATR NSUF partnership program, but are planned for future cooperative research activities. Through this part of the pilot, Sridharan's students were able to perform small angle neutron scattering (SANS) work at the Los Alamos Neutron Science Center (LANSCE), and evaluate irradiated samples at Argonne National Laboratory's APS.

Sridharan explains the pilot as it worked with other User Facilities, "It was a multi-institutional team effort," he says. "All of the potential future partners we contacted agreed to have their samples irradiated at the ATR. This required us to prepare all the samples for all these materials and to collect the thermophysical properties of each material." This effort required work on multiple levels. Sridharan continues, "For six months, we had weekly conference calls with the INL staff to make sure the samples were prepared, identified, and their properties documented properly. The

ATR NSUF staff was immensely helpful and patient in guiding us through the process and has also been very helpful with the post-irradiation examination (PIE) work that we are presently performing."

The pilot project faced a number of hurdles early on, and according to Sridharan, "When we started this project, there was no way to directly measure the temperature of sample capsules placed in those irradiation locations where it's not possible to place instrumentation leads, such as a drop-in capsule or the Hydraulic Shuttle Irradiation System (HSIS) or 'rabbit'." He continues, "To overcome this challenge, the INL developed an innovative process in which small, rectangular silicon-carbide (SiC) rods (adapted from Oak Ridge National Laboratory technology) were placed in selected capsules. Then we measured the resistivity changes in the rods before and after radiation and used the resulting data to back-calculate the temperature."

As his project winds down, Sridharan can look back over the successes he and his students achieved. The materials irradiated under his pilot will continue to provide analysis opportunities for future students and professors. His students can look back knowing they were the forerunners in a program to advance knowledge in nuclear science and engineering. All-in-all, a very good science project!

Principal Investigators Set the Pace



Dr. K.L. Murty is the director of graduate programs and a professor of nuclear engineering and materials science and engineering at North Carolina State University. Dr. Murty's primary areas of research include biaxial creep of zircalloys and radiation embrittlement of

ferritic steels. He is a Fellow of the American Society for Materials and the American Nuclear Society and a winner of the Alcoa Foundation Engineering Research Achievement Award and the Mishima Award from the American Nuclear Society.

Murty submitted a proposal to the first ATR NSUF call for proposals, and when asked what his motive was he explains, "It was a perfect storm of influences. First, some preliminary studies we did on small, grain-sized stainless steel samples had revealed relatively low levels of swelling. Then, one of my nuclear materials graduate students, Walid Mohamed, independently proposed the topic for his doctoral dissertation. I was also leading a couple of projects on nanograin structured materials (Cu, Al, Fe, and their alloys) that led us to realize we could add the effects of high-dose radiation exposure on the microstructures and material properties to the research. Then the ATR NSUF issued its first call for proposals, and we had a way to irradiate the materials at higher fluencies and test 'hot' samples."

It is important to Murty to have access to a reactor to irradiate materials, not only as a professor of nuclear engineering, but also from a broader perspective

"The International Atomic Energy Agency reports there are more than 500 nuclear power, research, and other reactors currently in operation worldwide. It is likely that the new generation of advanced nuclear energy systems will be designed to operate at higher temperatures, and extremely greater radiation levels than today's light water reactors. Accordingly, developing structural, cladding, and fuel materials that are highly resistant to intense radiation is an essential goal." The creation of ATR NSUF was therefore timely to Murty and other university professors seeking a way to explain what happens to materials in radiation environments.

Murty's initial goals were to help Mohamed obtain the analyses he needed to complete his dissertation. However the overall goals of the project are much broader.

"In harsh radiation environments, elementary material damage results in embrittlement and dimensional instability in both the structural and fuel components. We wanted to investigate how in-situ removal of these radiation-induced point defects would affect the mechanical properties of irradiated materials."

"Our hypothesis was that because nanostructured materials are characterized by large numbers of grain boundaries which can act as sinks for irradiation-induced defects, the materials in which they exist will be more resistant to radiation than their conventional, micrograined counterparts."

The project provided some surprising results.

"When we started this project, we considered nanograin-structured metals to be more radiation resistant due to their large number of interfaces, such as grain boundaries, that can act as sinks to radiation-induced defects. These materials were also quasi-stable in that their small grain sizes grow even at relatively low temperatures and their nanograin structures may not be stable in an irradiated environment. From this perspective, even though the materials may not be commercially applicable, they allow us to investigate the fundamental phenomena of defect production and subsequent annihilation during irradiation."

When the proposal was written, Murty proposed three different materials for his research: copper, nickel, and carbon steel. He explains the rationale for his choices.

"Copper is expected to exhibit grain growth during irradiation; nickel is expected to show grain shrinkage, and carbon steel was included due to its technological importance." However, what Murty discovered was something he did not expect. Post-irradiation examination has been completed for the nano-copper samples, and Murty tells us, "When irradiated at lower doses at both the PULSTAR (North Carolina State's reactor) and ATR, nano-copper clearly showed the competition between radiation hardening and in-situ grain growth; while at higher dosage levels, and as in-reactor grain growth reached saturation levels, radiation hardening dominated. We did not expect the results, and we're very excited to see if the carbon steel and nano-nickel samples are affected in similar ways. More importantly, we would not have achieved these results if the ATR NSUF facilities had not been available to us."

Of course not everything went smoothly for these first projects through the irradiation process. Murty describes his experience with a tone of seriousness.

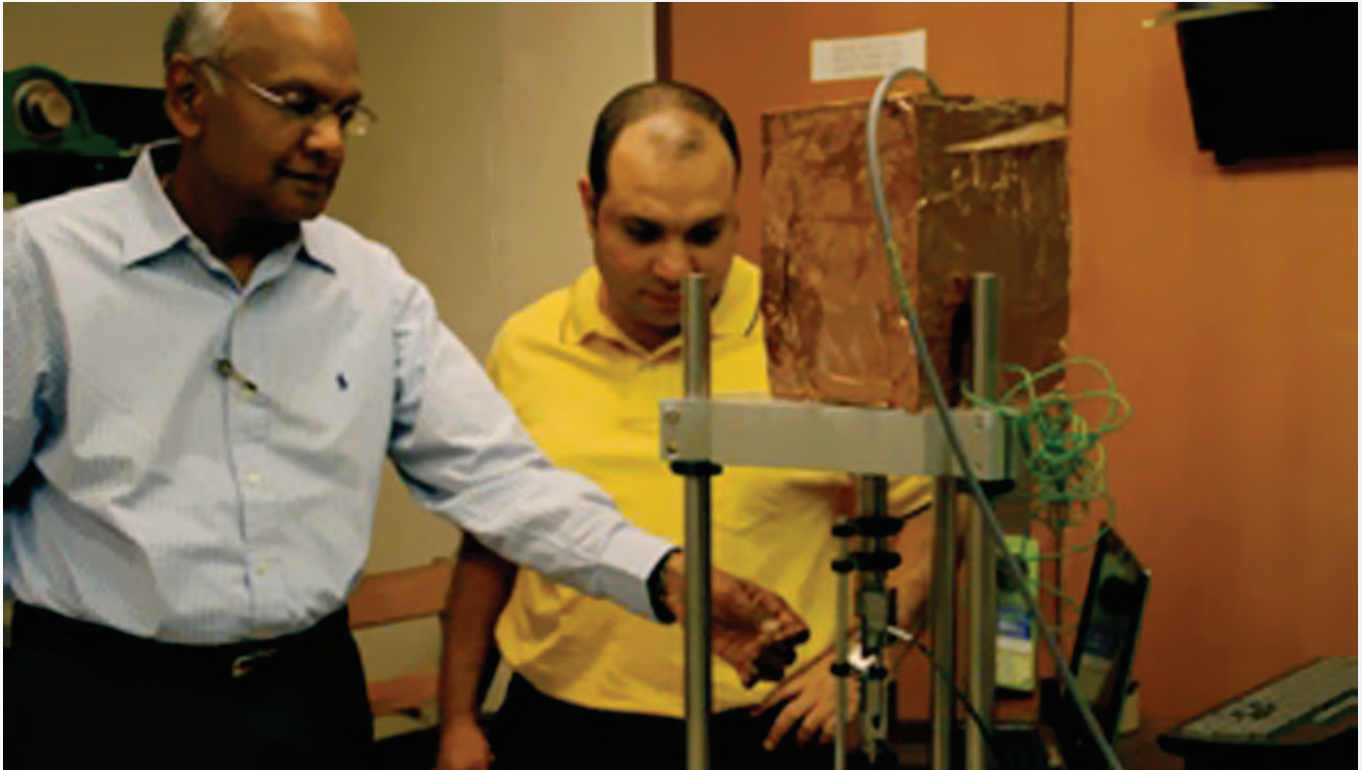

K. L. Murty (left) and Walid Mohamed (right) analyzing the results of their experiment.

“We were one of the first university groups to use the INL test facilities as part of the ATR NSUF program. As such, we faced initial ‘teething’ problems that delayed the project.” These hiccups proved more serious for Murty’s student Mohamed. “Ultimately we were only able to test one of the three materials we had irradiated. This was a big disappointment and changed the course of Mohamed’s dissertation.”

In spite of the difficulties Murty plans future proposals to continue analysis of both the nickel and carbon steel. Having the opportunity to continue this research is not only of interest to Murty, but to some of his students as well. Mohamed will complete his dissertation in May of 2012 as a result of this experiment, and the opportunity is not lost on Murty who has a new student ready to continue the research.

“The project has given our graduate students the opportunity to work with experienced personnel. The students experience the same difficulties they will encounter in the real world. Also, many of the experiments we perform at the ATR NSUF are just not possible at academic institutions, which usually are not equipped to handle ‘hot’ samples.”

Principal Investigators Set the Pace (cont.)



Dr. Juan Nino is an associate professor at the University of Florida. Nino's current areas of interest include high-frequency and high-temperature dielectrics and inert-matrix fuels for nuclear reactors. His awards include the 2010 International Educator of the Year and the J. Bruce Wagner Jr. Young Investigator Award from The Electrochemical Society in 2009.

When asked why he decided to propose to the first ATR NSUF call for proposals Nino was quick to explain.

“Not being a nuclear engineer, the main issue for me was realizing that most nuclear reactor problems are not physics problems but materials problems. As a materials engineer and scientist, it was very interesting to try to adapt my knowledge of materials processing and selection to the reactor environment so we could develop improved fuel forms.”

The fact that nuclear energy could be a real solution to meet future energy needs is of interest to Nino, especially as a materials scientist, but his concerns with the resulting waste are what drove him to research in this area.

“As we add these new reactors to our energy mix, we face two challenges in regard to future nuclear fuel forms: accident resistance and the reduction of radiotoxic waste. The ideal fuel form will thus be a new material that can be as effective and efficient as our current fuel but can be disposed of safely and is more resistant to accidents, both in and out of the reactor.”

Nino had a bit of good luck as he considered writing his proposal.

“When we were defining the project, we were inspired by the work of Pavel Medvedev of the INL. He had proposed using a magnesium-oxide-based (MgO) composite to

obtain an inert matrix possessing the optimum characteristics for hosting fissile material.”

“The main benefit of developing such a viable inert-matrix fuel is that even if there is no fuel-pellet separation and recycling, the amount of waste is significantly reduced, and that waste is much less radiotoxic.”

When asked, Nino describes specifically what he wanted his ATR NSUF project to accomplish.

“We wanted to design an improved fuel form. Originally, the fuel was envisioned as a two-phase, ceramic-ceramic composite material that can survive loss-of-coolant accidents while combining sufficient levels of thermal conductivity with a low neutron-absorption cross-section.” And there is a basis for this research according to Nino, “We have already shown that the thermophysical properties of the composites are quite good outside the reactor pile. Thanks to the ATR NSUF, we're investigating how these properties change after irradiation.”

As with the other two initial projects, Nino encountered some difficulties as one of the first experiments through the ATR NSUF process.

“The main challenge for me has been dealing with conflicting schedule constraints and the amount of paperwork required to perform experiments at a national laboratory. Such delays and extended waiting periods are a concern since our students can only graduate after completing their theses and dissertations, which in turn, is dependent on the completion of their projects, and many times that is completely out of their hands.”

“We're trying to be patient with the existing procedures, while working within the system so students can graduate as close to 'on time' as possible.”

In spite of this criticism, Nino has some good things to say about the program.

“The ATR NSUF staff has fully supported—financially, intellectually, and experimentally—the studies of my graduate student, Donald Moore.” This was an opportunity Moore took full advantage of, and because of it, he takes some invaluable experiences into his future after graduation.

Overall Nino is happy to have had the opportunity to perform his experiment.

“Having access to the ATR NSUF is clearly priceless. Without it, we would have never been able to test our materials under irradiation. Our project would have ended with plenty of very interesting data but with no evidence of each material’s performance under irradiation.”

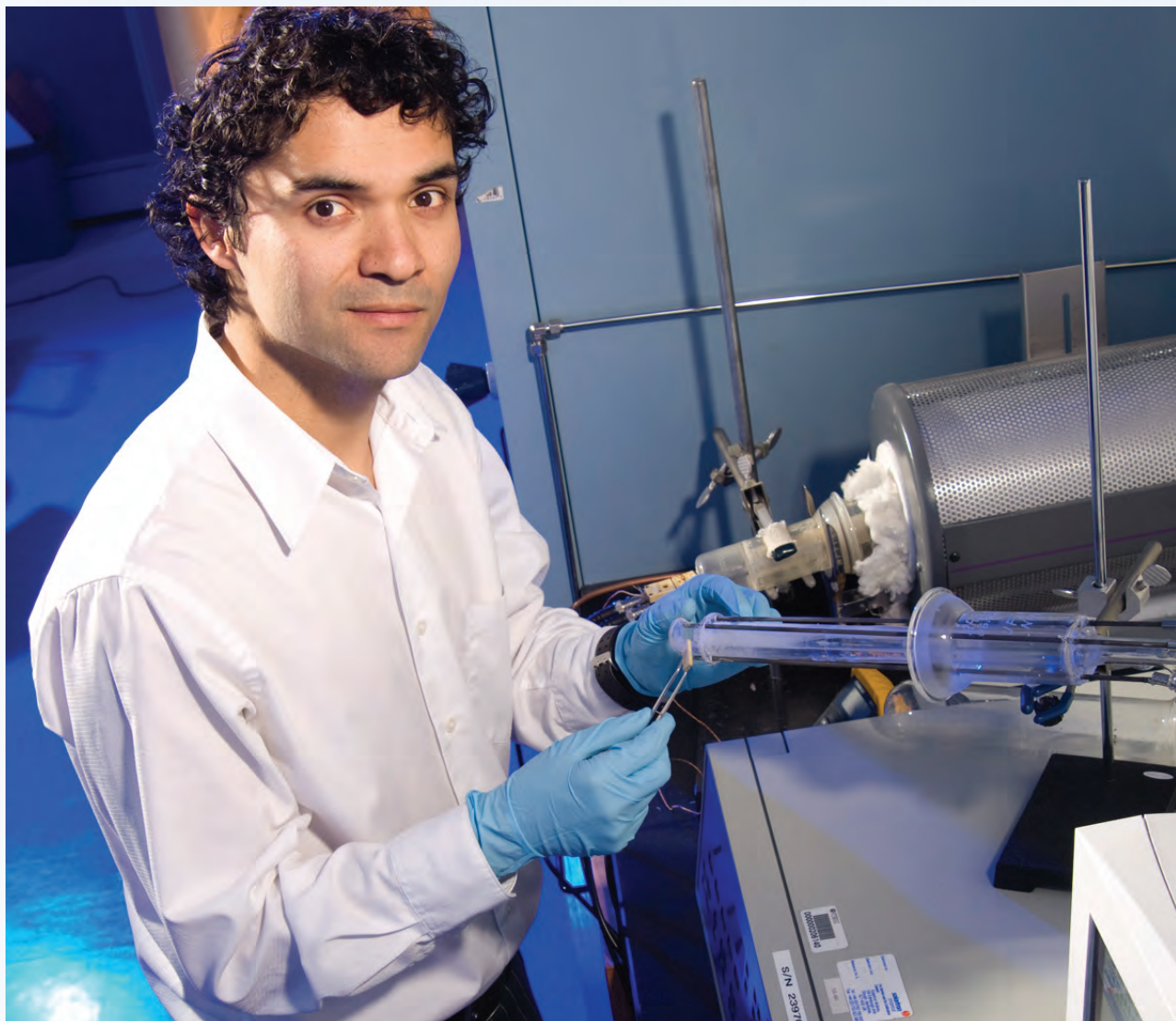

Juan Nino preparing samples for irradiation.

Students—The Next Wave of Knowledge

Just as the ATR NSUF has proven to be a vital resource for university principal investigators it is also an important learning tool for their students. Three of the students involved in the initial experiments explain why this experience was so valuable to their education, and what their future plans are as they graduate college.

Alicia Certain, University of Wisconsin



When the Purdue University rowing team showed up in Madison for a scrimmage with the University of Wisconsin (UW), lightweight crew member Alicia Certain found herself taken with the city. Then she discovered that UW had a great materials science department, which just happened to be her undergraduate field of study, and she was sold on the program for her graduate work. Six years and a lot of hard work later, she's set to graduate from UW in May 2012, with her Ph.D. in materials science as part of the next new wave of knowledge to enter the nuclear arena.

It was a summer internship at the Donald C. Cook Nuclear Plant in Michigan during her junior year at Purdue that first sparked her interest in nuclear energy.

"I've always been interested in the field of energy in general," Certain says, "and nuclear energy presents some unique materials science challenges."

During her second year at UW one of her professors, Dr. Kumar Sridharan, asked her to be part of a pilot project he was heading up in partnership with the Advanced Test Reactor (ATR) National Scientific User Facility (NSUF) in Idaho. She soon learned it would not only call on her materials science skills, but some lessons learned during her years on the Purdue rowing crew as well.

"There's certainly an aspect of teamwork and perseverance that is useful and necessary in both the science and the sport," she says with a wry grin.

The experiment involves performing neutron irradiations at various temperatures on a broad spectrum of alloys and geometries used in nuclear reactors. She knew immediately the opportunity would help further her ultimate career goals.

"From a scientific perspective, we're examining the effects of low-dose irradiation on a suite of engineering alloys being considered for use in the design of new nuclear reactors," explains Certain. "Neutron irradiations are considered the most realistic simulation of the reactor environment's effects on materials. It lends legitimacy to ion irradiations when neutron irradiations support the results."

Dr. Sridharan is quick to point out her contributions to the project.

"Alicia has been involved almost since its inception," he says proudly, "investigating the stability of oxide nano-particles in oxide dispersion strengthened (ODS) steels using ion and neutron irradiations. She has done a remarkable job, traveling extensively to national labs and universities and performing research independently. One significant highlight of her work has been to establish a collaborative relationship with the National Institute of Standards and Technology (NIST), where she performed work on small angle neutron scattering (SANS)."

He also points to her ground-breaking work on modeling the stability of oxide nano-particles in steels, which has



Certain hitting the "slopes."

provided the foundational work for the design of next-generation nano-structured steels.

“Her work using atom probe tomography (APT) and local electron atom probe (LEAP) techniques to quantify micro-segregation due to radiation has paved the way, and set the standard for future students,” he adds.

Her research travels included a number of visits to the Pacific Northwest Nuclear Laboratory in Hanford, Washington, where, coincidentally, she has accepted a position after she graduates from UW.

“My husband used to live in Seattle, and we love the area. Plus, I really enjoyed the people I worked with there,” says Certain. “My experience was a really positive introduction to the national lab research environment.”

There’s not much in the way of competitive rowing around Hanford, but Certain says she’ll be happy to take advantage of some great skiing instead.

Walid Mohamed, North Carolina State University



After completing both his bachelor and master’s degrees in nuclear engineering in his hometown of Alexandria, Egypt, Walid Mohamed began looking for a good Ph.D. program. He got a lot of recommendations for North Carolina State University (NCSU) from other Egyptian students who had attended the school. The fact that its department of

nuclear engineering is consistently ranked among the top five or six in the U.S., along with the availability of the PULSTAR reactor on campus, helped make his decision to choose the prestigious university relatively easy.

During his first year at NCSU, a term paper he had written examining nano-crystalline metals for Gen IV nuclear reactors, caught the eye of his professor, Dr. K. L. Murty, and they both agreed it would make a good topic for Mohamed’s doctoral degree. Together they launched irradiation experiments on nano-structured metals at PULSTAR, but only at relatively low-dose levels. Furthermore, researchers had to wait six months or more for the samples to cool to a point where they could be tested. As luck would have it, that’s about the time the ATR NSUF was putting out a call for research proposals to universities. Any experiments awarded through this call would be granted access to the ATR and post-irradiation facilities at the Idaho National Laboratory. This would allow them access to facilities where they could test samples at much higher fluencies, and test “hot” samples for microstructural and mechanical property characterizations. Mohamed’s project was one of the first five awarded by the ATR NSUF.

“I have always believed that nuclear engineering will have a major impact on the future of the world because of increasing energy demand,” says Mohamed. “All the neutronic and thermal hydraulics calculations being done for the next generation of nuclear reactors seem so interesting, but they are all just dreams until the proper nuclear materials are available to bring those designs from paper to reality.”

As with any new partnership, there are kinks that needed to be worked out. Not only was Mohamed the first student to be granted access to the ATR NSUF facilities at INL, he was the very first foreign national. At the time there was no specific protocol in place for that situation.

“Every time I tried to get access to one of the facilities at INL it seemed like I had to get some additional training,” says Mohamed. “One time I had to wait almost two weeks to get proper permission to use the electron microscopy lab, and by the time I got access we figured out that in order to use the computer in that lab I had to get another permission. There was some fun in it, however, and all the difficulties I encountered helped the folks at INL prepare a procedure to facilitate foreign nationals coming to their facilities in the future.”

Although samples from three different materials were irradiated in the ATR, the initial protocol problems resulted in the team being able to test only one of them in 2011. But even though Mohamed will be graduating

Students—The Next Wave of Knowledge (cont)

with his Ph.D. in May 2012, thanks to the new “rapid turnaround” project venue recently established at the INL other students will be able to carry on his work testing the remaining materials, and on a much shorter timeline.

“This project gave us all an excellent opportunity to work with experienced personnel at INL,” says Dr. Murty. “Walid and the other graduate students worked not only with the scientific personnel, but also administrative people to make the various arrangements that would ensure the work was performed as planned. Equally important, they got a chance to encounter some of the difficulties found in the real world, where things often just don’t go as planned. These experiences will definitely be of great value in their professional careers.”

“After graduation, I would like the chance to join one of the national laboratories,” says Mohamed, “so I can expand my research interests and experience. But my ultimate goal is to have a faculty position so I can continue being involved in scientific research and have the chance to do what I am most fond of, teaching others what I have learned.”

In addition to all the hard work his studies at NCSU entail, Mohamed and his wife are raising two young boys, now ages four and one. That alone should qualify him as a major multi-tasker, a highly valuable skill when he joins the next wave of knowledge.



Mohamed and his one-year old son Moamin.

Donald Moore, University of Florida



Born in California, Donald Moore’s family moved to Florida when he was in middle school, and soon he had his sights set on the University of Florida (UF). He was attracted not only by their excellent engineering programs, but also by their great sports programs. He attacked his undergraduate studies with the same tenacity he displayed on the basketball court, both on his high school team and an intramural team he played with through college.

Moore will complete his undergraduate degree in materials science and engineering, with a minor in business administration. He expects to graduate with a master’s degree in materials science in August 2012.

“I chose materials science,” Moore explains, “because it incorporates elements of chemistry, which was one of my favorite classes in high school, and materials structure property relationships for engineering applications.”

In his first year as an undergraduate Moore dove right in, joining a research group headed by Dr. Juan Nino. Assisting another graduate student, he began fabricating samples for Dr. Nino’s ATR NSUF project. Two years later, in 2009, he took his first trip to INL to assist in loading those samples into capsules that would go into the ATR.

“I enjoy solving problems,” says Moore, “and having the materials science background, I was drawn to nuclear science because I wanted to understand how irradiation affects materials’ properties. I’m particularly interested in inert matrix ceramic nuclear fuels, which many scientists believe could make future reactors more sustainable.”

His participation on Nino’s experiment at the ATR NSUF allowed him to work as a “student user” the following two summers, where he assisted with the post-irradiation



Moore ready to cheer on the Florida Gators.

examination of his samples, bringing his involvement in the project full circle.

“We’re looking at the effect of radiation on the structure and thermal properties of inert matrix materials,” Moore says. “It’s critical to our goal of developing safer ways to dispose of nuclear waste.”

“The knowledge Don gained at INL working with the ATR NSUF is invaluable,” comments Nino. “Working in a national laboratory as a “student user” gives students experiences rarely available in a university setting. Performing this type of hands-on work broadens their intellectual and experimental scope and provides them with a ‘big picture’ view of the nuclear fuel cycle as well as unique insight into the critical engineering issues surrounding nuclear reactors.”

Moore was selected for the project while still an undergraduate because of his motivation, dedication and attention to detail. Those same qualities also helped build

a strong link between researchers at INL performing ATR NSUF work and UF.

According to Nino, “Don is the glue that has kept the project running by keeping all of us, both at the UF and the INL, on the same page. He not only does his own work, he helps push the work that’s not under his control and facilitates the processes to make sure everybody else’s work is performed.”

“I ultimately want to pursue a Ph.D. in engineering or a master’s in engineering management,” says Moore, “but first I’d like to work in the industry for a couple of years to gain experience and determine which degree will better allow me to move up in engineering management.”

When that next wave of knowledge hits, you can bet Donald Moore, who just happens to love the beach, will be riding the crest.

ATR NSUF Partners –The Energy of Collaboration

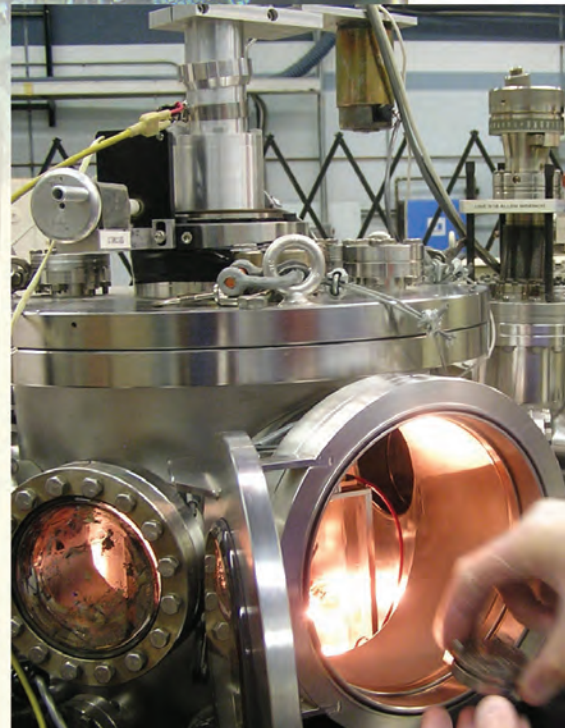

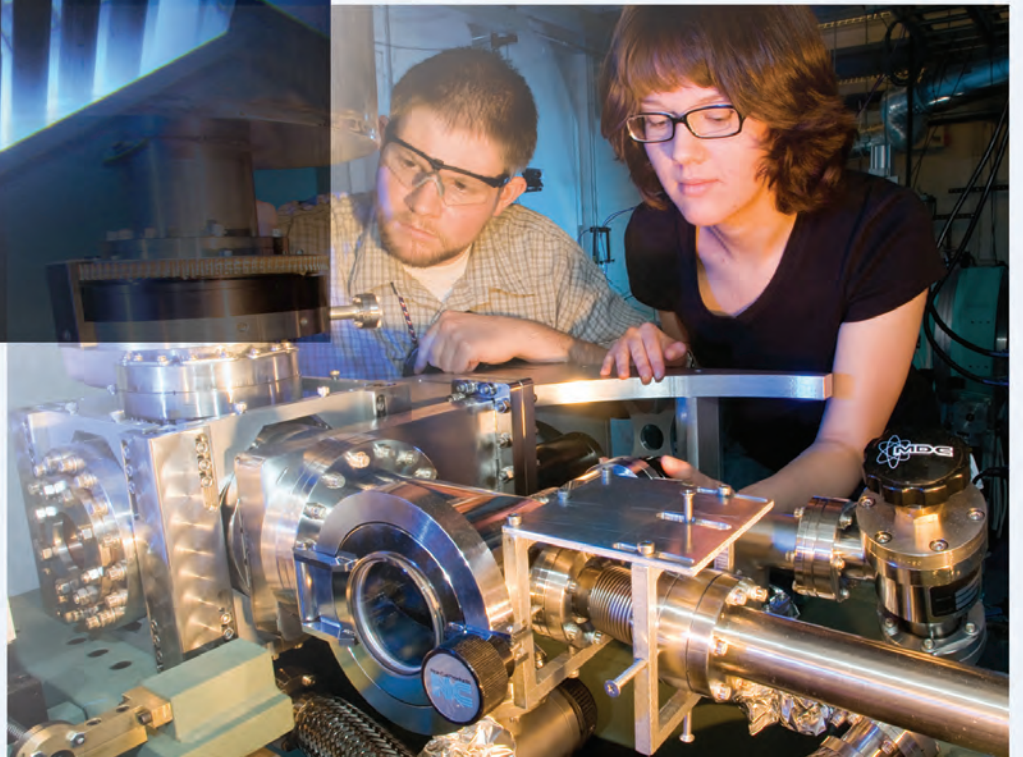
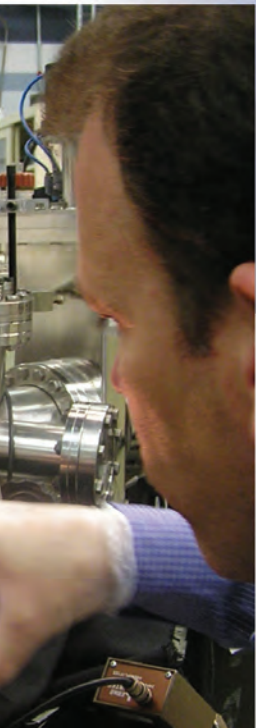

Partner–Illinois Institute of Technology Continuing a History of Nuclear Research

On June 28, 1956, the first privately-owned nuclear reactor ever built in the U.S. began operation at the Armour Research Foundation in Chicago's Illinois Institute of Technology (IIT). The 50,000-watt reactor, fueled by enriched uranium dissolved in about four gallons of water, gave industry its first green light to conduct reactor studies without government security restrictions. Its most frequent use was the production of radioisotopes to be used in the study of chemicals and various materials.

Fast forward half a century and IIT has become one of the foremost nuclear research facilities in the United States, and one the ATR NSUF is proud to have on its list of Partner Facilities. While the original reactor was dismantled in the 1980's, nuclear research at IIT continues through the Center for Synchrotron Radiation Research and Instrumentation (CSRRI) facilities, located at the nearby ANL APS, which provides the brightest storage ring-generated X-ray beams in the western hemisphere.

In operation at ANL since 1996, the CSRRI actively fosters and coordinates research and educational activities in synchrotron radiation science and related fields at IIT. The center promotes the application of the tools and techniques of this critical field to science and engineering research in fields as diverse as biophysics, physical chemistry, x-ray physics and materials science, among others.



The McCormick Tribune Campus Center at IIT in Chicago where the 2012 Nuclear Science Week BIG EVENT was held.

"One of the principal techniques we work on with users of the ATR NSUF is x-ray diffraction," explains Dr. Jeff Terry, Associate Professor of Physics at IIT, and chair of the ATR User Organization Executive Committee. "We can do in-situ tensile loading while we do the diffraction, on both radioactive and non-radioactive samples. We also do x-ray absorption spectroscopy, micro-focus mapping and tomography on samples from plutonium to irradiated steels, and have successfully performed experiments on many of these types of materials with the ATR. We continue to work hard to open up experiments on nuclear materials and irradiated structural materials to these advanced characterization tools."

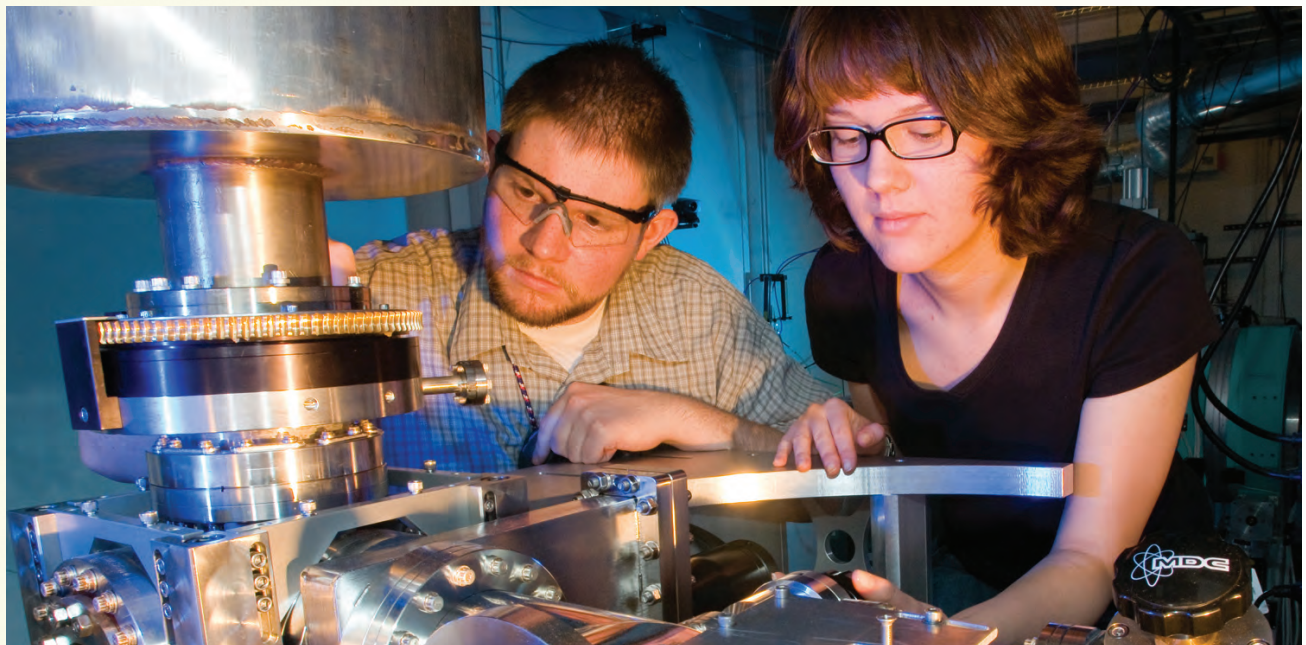

Dan Olive (left) and Yulia Trenikhina (right) working on an environmental chamber at the MRCAT beamline.

The CSRRI operates two sectors at the APS. The Biophysics Collaborative Access Team (BioCAT) operates an undulator-based beamline, along with associated laboratory and computational facilities, focusing on the study of partially ordered and disordered biological materials.

The Materials Research Collaborative Access Team (MRCAT) is itself a partnership between IIT, Notre Dame, the University of Florida, the Biosciences and Chemical Sciences, and Engineering Divisions of ANL, BP, Inc., Honeywell UOP, and the U.S. Environmental Protection Agency. Featuring both an undulator (10-ID) and a bending magnet (10-BM) beamline, MRCAT utilizes techniques such as x-ray absorption spectroscopy (XAS) for local structural studies of materials and environmental systems; a hard x-ray microprobe for heavy element distribution, speciation and XAS; as well as deep x-ray lithography and photochemistry. Specialized capabilities include rapid scan XAS, a 19-element detector for very dilute systems, along with in-situ and radioactive materials studies.

IIT scientists are also firmly committed to the educational mission of the CSRRI. One example is the Graduate Assistantships in Areas of National Need (GAANN)

Fellowship Program in Synchrotron Radiation Research, which supports graduate students pursuing Ph.D.s in physics with that particular specialization. In addition, the center provides services for beamline construction, operations and maintenance, both within IIT and contracting for other beamline facilities, through the State Electricity Regulators Capacity Assistance Training (SER-CAT) sector.

“We have loved being a partner of ATR NSUF,” Dr. Terry says, “because they have brought in many people who have never used our facilities before. It has helped us strengthen our ties with Argonne, and with the Department of Energy. We hope to continue working together a long time into the future.”

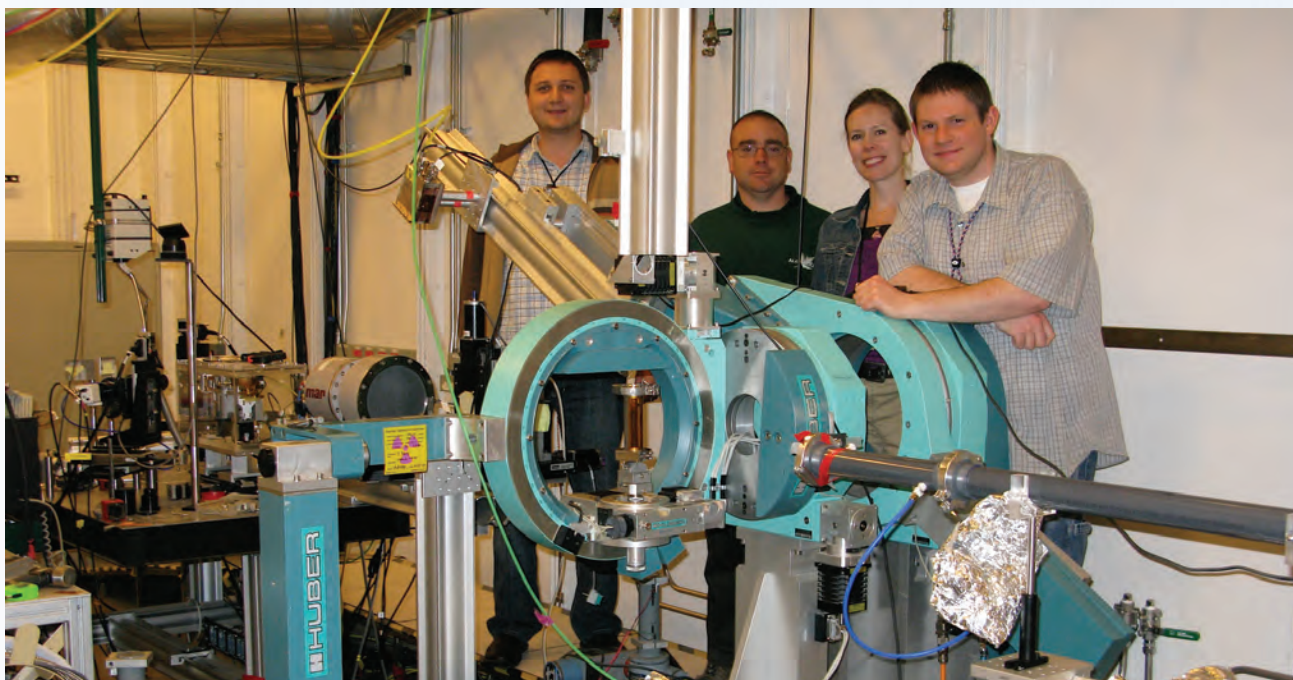

(left to right) Levente Balogh, Don Brown, Maria Okuniewski, and Dan Olive conducting an x-ray diffraction experiment at the MRCAT beamline.

Partner—Massachusetts Institute of Technology Meeting the World’s Great Challenges

On June 14, 1916, approximately 1,500 Massachusetts Institute of Technology alumni gathered at Symphony Hall in Boston to celebrate the opening of the new MIT campus in nearby Cambridge. Over the course of the evening, more than three million dollars were raised, but the real highlight of the evening was that the events at Symphony Hall were broadcast via telephone to alumni clubs and guests gathered in 34 different locations throughout the country. The American Telephone Company, who set it all up, boasted that this was “the most elaborate trans-continental telephone stunt ever staged.” Most likely, it was also the first-ever conference call.

MIT alumni clubs from Duluth to San Francisco to New Orleans were able to listen to speeches by special guests that included Alexander Graham Bell and Orville Wright. The Milwaukee club transmitted a rendition of “The Stein Song,” and the night ended with everyone singing the “Star Spangled Banner.” The telephone banquet was just

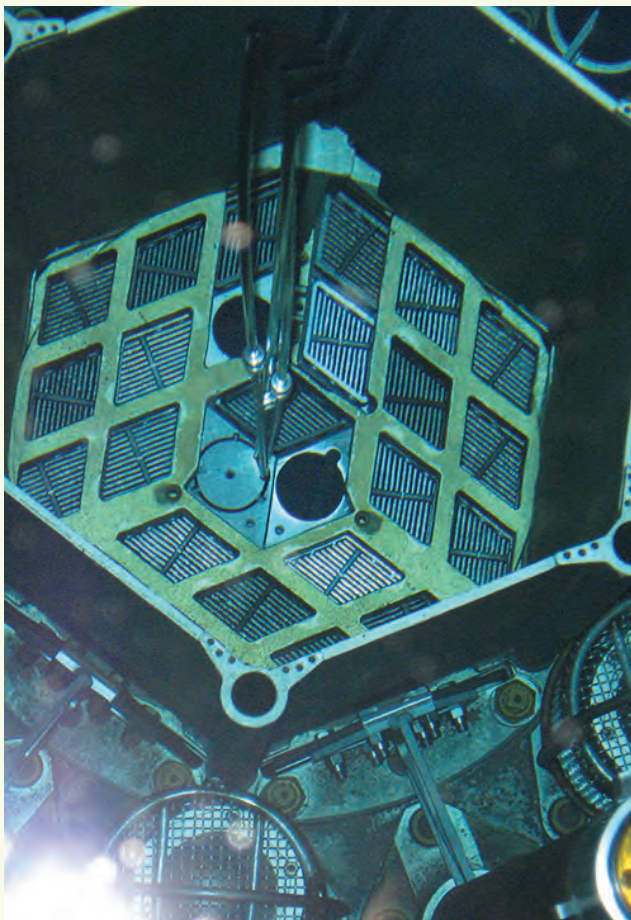

MIT reactor core with fuelled in-core experiment installed.



MIT NRL reactor floor hot cell in use for in-core experiment disassembly.

one of many elaborate events held in celebration of the new MIT campus. *Technology Review* magazine called it “the greatest celebration ever held by any institution of learning in the world.”

Ever since the first students began attending classes at the original Boston campus in 1865, four years after it was incorporated by the Commonwealth of Massachusetts, MIT has sought nothing less than to embody the vision of its first president, William Barton Rogers. His goal was to establish a new kind of independent educational institution, relevant to an increasingly industrialized America. Today, with 77 Nobel Laureates, 52 National Medal of Science winners and 38 MacArthur Fellows among its graduates, MIT has achieved that goal in world-class fashion. It should come as no surprise, then, that when it proposed making its Nuclear Reactor Laboratory (NRL) available for experiments that could not be accommodated at INL's ATR, MIT became the first of the ATR NSUF partner facilities in June 2008.

“This partnership has greatly increased the utilization of the in-core facilities at the MIT reactor (MITR),” explains Dr. Gordon Kohse, principal research engineer. “Bringing together researchers from the INL and other partner institutions creates invaluable opportunities to learn how others have addressed the many common challenges in in-core experiments, and to work jointly on solutions and improving facilities.”

Teaching and research—with relevance to the practical world as a guiding principle—continue to be MIT’s



As-fabricated components of the fueled in-core facility before sample installation.

primary mission. The community of scientists, researchers and students performs cutting edge research across a wide range of disciplines. It is particularly strong in bringing together cross-disciplinary teams to tackle difficult problems. One example is MIT's Energy Initiative (MITEI), launched in 2006 to help transform the global energy system and provide for future energy needs. MITEI works to promote ties between industry and the university in a number of energy fields, including fission and fusion, and to engage students in relevant energy research.

The fission energy program is carried out primarily at the Center for Advanced Nuclear Energy Systems (CANES),

a joint program between the Nuclear Science and Energy Department (NSE) and the MITEI. The CANES mission focuses on the development and application of new methods in the design, operation and regulation of nuclear reactors and fuel cycles. Complementing this effort, the NRL is home to a robust experimental program in fission energy technologies that are applicable to a wide range of reactor types, from current generation light water reactors (LWR) to the high-temperature gas reactors of the future.

The in-core experimental program is supported by several hot cells and hot laboratories where in-core experiments can be disassembled and post-irradiation examinations (PIE) can be carried out utilizing gamma spectroscopy, scanning electron microscopy and eddy current oxide thickness testing, among others. These advanced technologies make the MITR a valuable training tool for nuclear engineering students, and typically has ten or more licensed student operators.

"The NRL brings together a uniquely valuable set of resources," Dr. Kohse explains. "In addition to operating one of the most powerful university research reactors in the U.S., it is committed to an ambitious in-core research program aimed at improving the safety, reliability and economics of current-generation reactors as well as advanced designs being developed for future use."



Irradiated SiC/SiC composite clad tube undergoing burst testing.

Partner—North Carolina State University

A Unique Facility Builds on a Proud History

In the field of nuclear research at the university level, North Carolina State University (NCSU) has one of the most impressive resumes in academia.

It was the first nuclear engineering curriculum on campus. Any campus.

In the fall of 1953, the headlines in the scientific journals talked about the world's first university-based reactor—aptly named the R-1 reactor—going critical on the NCSU campus, but the real story was that the school had concurrently established the planet's first university-level nuclear engineering degree-granting program.

Dr. Clifford Beck had been recruited from Oak Ridge National Laboratory to overcome the very significant challenges of the time: public resistance to this entirely new discipline, the complete lack of textbooks, and national security limits on the availability of information about nuclear reactors.

Nonetheless, Beck and his team designed undergraduate and graduate programs and ultimately gained approval for curricula leading to B.S., M.S., and Ph.D. degrees in the nuclear sciences.

At 1:52 a.m. on September 9, 1972, the world's second PULSTAR reactor went critical on Engineering Row on the NCSU campus. Today, it is the only operational reactor of its type in the world.

The NCSU PULSTAR is a 1-MW, pool-type research reactor with six beamports that uses pin-type fuel consisting of uranium dioxide pellets in a zircaloy cladding. This fuel configuration creates response characteristics that closely mirror those of a commercial light water power reactor. Combined with the reactor's singular design, it allows researchers to create supercritical operational scenarios not possible with many other types of research reactors in a safe, controlled environment.

It's also considered a perfect complement to INL's ATR in that it produces a lower, less intense level of radiation than the ATR. Thus, researchers can monitor irradiated materials as their microstructures evolve more slowly than they would be able to do in the ATR.

As a partner of the ATR NSUF, the PULSTAR provides scientists a greater degree of flexibility, depending on the type and scale of irradiation desired.

As you'd expect of a research reactor on a university campus, the PULSTAR is an excellent teaching tool. "The

PULSTAR allows us to recreate some important reactor-physics concepts," explains Dr. Ayman Hawari, director of NCSU's nuclear reactor program. As an example, he points out how NCSU students conduct experiments on the reactor that measure temperature and power reactivity coefficients including Doppler feedback. "We can also examine the combined reactivity feedback effects," he adds, "that occur during reactor start-up and power operations."

The PULSTAR is also an important part of NCSU's efforts to carry nuclear science education to students outside its campus. Through its Internet Reactor Labs (IRL) project, NCSU offers access to the PULSTAR reactor to academic institutions—both domestically and internationally—who don't have research reactors of their own. Students send samples to NCSU for insertion in the reactor then, through direct video and audio links, remotely use the reactor to conduct research, work directly with NCSU reactor operators, and observe the reactor's behavior via a virtual control panel.

In November 2010, IRL enabled PULSTAR to become the first U.S. research nuclear reactor to be used for educational purposes outside the United States. The reactor was linked to the nuclear engineering department at Jordan University of Science and Technology (JUST), forming the first reactor laboratory in Jordan.

NCSU doesn't limit its educational efforts to university students, either. Every summer, it offers instructional camps to high school students and their teachers, as well.

While PULSTAR is unquestionably a valuable teaching and research tool, NCSU also provides additional

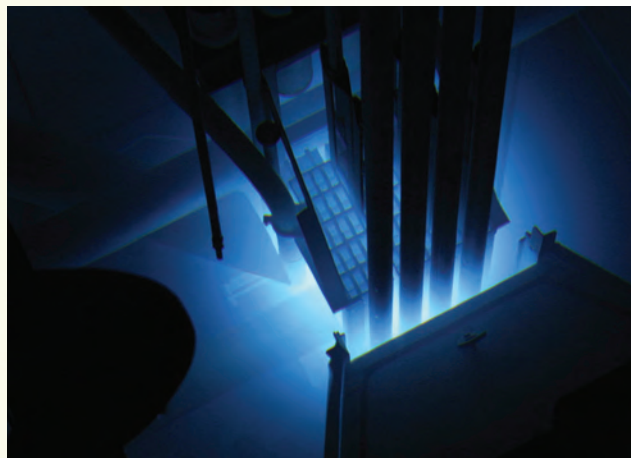

The heart of the reactor: the PULSTAR core.



The brains of the reactor: the PULSTAR control room.

resources for the world’s researchers. As Dr. Hawari notes, “At North Carolina State, we can provide radiation for an extremely wide portfolio of experiments.” Beyond the PULSTAR, some of the resources offered to ATR NSUF users include:

- Neutron imaging and radiography – a powerful non-destructive imaging technique for evaluating materials and components. Unlike X-ray imaging which interacts with the electron cloud surrounding the nucleus of an atom, neutrons interact with the nucleus itself.
- Powder-diffraction facility – used to understand the correlation between material properties and material structure by enabling the study of the fundamental crystal structure, position, and chemical species of the constituent atoms; the species, location, concentration of impurities; and the nature of structural defects.
- Intense positron beam (the only facility of its type in the U.S.) – positrons implanted through low-energy beams better control implantation depth, enabling the study of porosity in thin films, surfaces, interfaces, and depth-dependent phenomena.
- Ultra-cold neutron source – creates very slow moving neutrons, which allows longer observation times and leads to a significantly improved experimental measurements, especially when investigating surface or near-surface conditions.
- Accelerator-based Neutron Source – scheduled for initial operation in Spring 2012, the new neutron source will be “highly complementary” to the PULSTAR reactor, enabling of materials using nuclear properties.

Partner—Oak Ridge National Laboratory Appalachian Atoms

It was 1942. The world was at war. Only a handful of people knew that its outcome ultimately lay not in the hands of soldiers, but of scientists, many of whom had fled Europe in the 1930's as Fascist dictators seized power. They knew that whichever side could become the first to build an atomic bomb would hold the fate of the world in its hands. And so it was that a small group comprised of an Italian, Enrico Fermi, and Hungarians Edward Teller, Leo Szilard, John Von Neumann and Eugene Wigner, found themselves deep in the Appalachian Mountains of eastern Tennessee the following year, building the world's first operational nuclear generator for what would become known as the Manhattan Project.

The Graphite Reactor, as it was known, played an important role in refining plutonium for the first nuclear weapons. After the war, ORNL added several experimental and research reactors, forerunners of the radiochemical processing and post-irradiation examination facilities necessary for today's nuclear research and development. Neutron scattering science had its beginning at ORNL. It became the world's first source for medical radioisotopes and a major center for nuclear reactor

technology for peaceful purposes. Small wonder ORNL is such an important link in the national partnership matrix developed by the ATR NSUF.

“ORNL's nuclear science and engineering capabilities complement those of ATR NSUF,” says Chris Bryan, liason to the ATR NSUF. “Our history at Oak Ridge is one of collaboration and focusing our respective strengths together to address the nation's nuclear energy challenges. This is further galvanized by our participation in the ATR NSUF's partner program.”

Today ORNL is one of the largest, most diverse national laboratories in the entire Department of Energy (DOE) system. Managed for the DOE by UT-Battelle, the lab focuses on current challenges in neutron science, energy, high-performance computing, systems biology, materials science and national security. In addition to partnering with other national laboratories, ORNL partners with the state of Tennessee, 200 universities and multiple industries. Through licensing and other agreements, ORNL aggressively moves its technologies into the commercial marketplace.

In pursuit of scientific breakthroughs, the laboratory hosts a DOE Leadership Computing Facility and its Titan supercomputer, as well as the Center for Nanophase Materials Sciences, the Bio Energy Science Center, and the Consortium for Advanced Simulation of Light Water Reactors. It is also home to the Spallation Neutron Source (SNS), the High Flux Isotope Reactor (HFIR), and a set of complementary nuclear and radiological facilities that include the Radiochemical Development Engineering Laboratory.

Associated R&D programs at ORNL, employing facilities such as the HFIR and SNS, are establishing

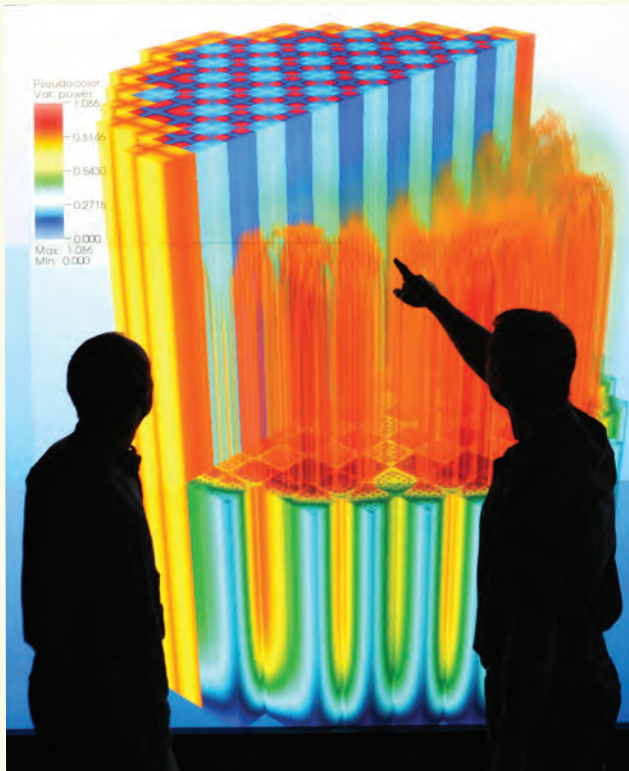

CASL visualization facility.



North hot cell.

the scientific basis for materials behavior in a fusion environment, tritium breeding, and reliable and efficient power extraction. Recent work has demonstrated that tristructural-isotropic (TRISO) fuel particles have the potential to substantially improve performance in fission reactors over traditional monolithic ceramic fuels.

“In recognizing nuclear energy as an important element in the future energy mix,” says Laboratory Director Dr. Thom Mason, “ORNL’s combined efforts are aimed at advancing the safety and cost-effectiveness of fission power, and in developing fusion science and technology for the International Thermonuclear Experimental Reactor (ITER) era.”

With its capabilities in materials science, radiation effects, atomic and plasma boundary physics, and intense plasma heating systems, ORNL is strongly positioned to make critically needed contributions to addressing and resolving the scientific and technical issues of advanced nuclear energy systems. Recognizing the similarities in requirements for advanced fission and fusion materials, ORNL will explore the potential of advanced fission materials as part of its future mission.

HFIR removing inner fuel element.



Oak Ridge National Laboratory campus.

Partner–University of California, Berkeley “City of Learning” Continues Tradition

Not long after California became the nation’s 31st state in the wake of the famed gold rush, the first University of California was chartered. Its leaders envisioned a “City of Learning,” and the campus at Berkeley has lived up to that credo with a veritable fruit cocktail of accomplishments. Among its graduates, UC Berkeley counts such disparate celebrities as Rube Goldberg, the cartoonist whose name has since become an adjective, and John Muir, who co-founded the Sierra Club in 1892. The faculty, which includes some 22 Nobel Prize winners, is no less distinguished. In 1922, vitamin E was discovered by anatomy professor Herbert Evans and Dr. Katharine Bishop, and in 1931, Ernest Lawrence designed the first cyclotron, launching the scientific use of particle physics.

The 1940’s saw the identification of the flu virus, as well as the solving of the riddle of photosynthesis at UC Berkeley. And the list goes on, from the discovery of a lost Scarlatti opera, to the drafting of the first no-fault divorce law in the 1960s’, and yes, even the creation of the literal, canned fruit cocktail by Berkeley food technologist William Cruess, chair of the Division of Fruit Products in the 1930’s.

The Department of Nuclear Engineering was established in 1958, joining the more than 350 academic programs now offered to Berkeley’s 36,000 students. It is the only such program in the entire California state university system. About 70 of Berkeley’s 10,000 graduate students study nuclear engineering on campus, but their research projects also benefit from strong collaborations with the Lawrence Berkeley, Lawrence Livermore, and Los Alamos national laboratories.

Dr. Peter Hosemann, an associate professor in the materials science department, leads the materials group for nuclear implications.

“There are several groups within the department,” explains Hosemann. “Three are working in the detection of nuclear materials and threat reduction, while another works on nuclear reactor design. Yet another explores thermal hydraulics. Then there are the physicists, who study nuclear reaction and fission products on a basic scientific level. Our materials group is focusing on the development and long-term reliability of materials used in nuclear power plants.”



Students collaborating at the nano-indenter.

All this collaboration made Berkeley a natural candidate for the ATR NSUF's partnership program. Besides housing multiple transmission electron microscopes (TEM) its materials characterization laboratory is home to one of only a few focused ion beam (FIB)/scanning electron microscopy systems (SEM) in the U.S. that allow radioactive materials. In addition the nuclear materials group has the only high-temperature (<750°C) nano-indenter allowing radioactive materials.

“We have some very unique capabilities,” says Hosemann, “which are very specific but also very essential. I thought it would be great to have them available to other users as well, in order to enhance the scientific output of the national program. There are irradiated materials available, and the bottleneck of post-irradiation characterization can be overcome if we all work together using advanced techniques and a large variety of instruments to give us the most information possible on these highly valuable specimens.”

Though only a little over a year old, the Berkeley/ ATR NSUF partnership is already reaping benefits, for Berkeley as well as the outside users who are now able to take advantage of its facilities.

“I get frequent requests to use our equipment from non-ATR NSUF PI’s,” Hosemann says. “It gives us good visibility and brings in new, interesting projects. As

new tools become available, the tests become more sophisticated. You can test smaller amounts of radioactive material and get much more relevant and useful results. And with all the materials coming out of the Advanced Test Reactor (ATR) these days, I expect to see an increase in users from around the country, even internationally.”

Indeed, a group from Japan is making inquiries about using the Berkeley labs, and another group from Korea is already working on a project within the framework of the International Nuclear Energy Research Initiative (I-NERI) to create the smallest mechanical test they can perform and still get reasonable data for nuclear application. In addition to developing more radiation-tolerant materials for reactor construction, Berkeley researchers are also working on

designs for better fuels and waste forms.

“It is almost never the creativity of an engineer that limits the realization of newer and safer reactor designs,” says Hosemann, “but rather the materials and fabrication techniques available to them. Combining theory and experiments, with the application in mind, helps us solve fundamental issues and leads to better solutions.”

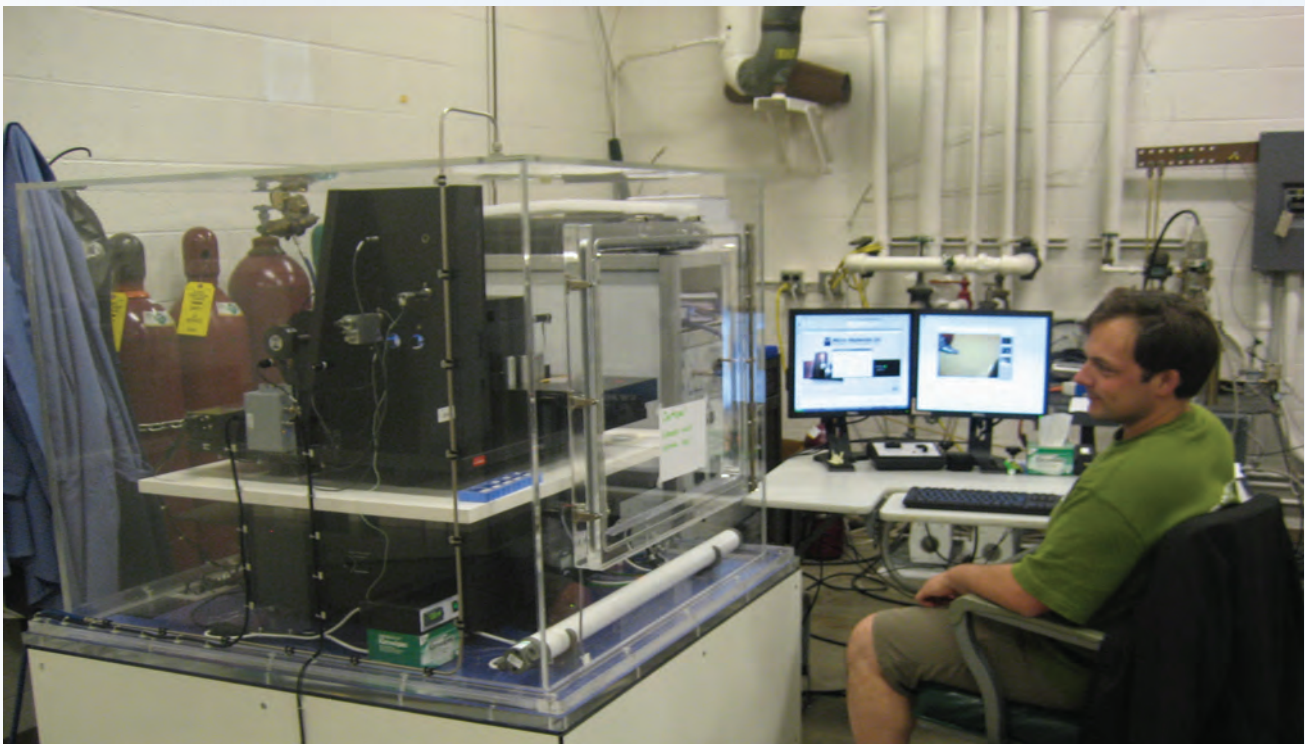

Peter Hoseman working at the nano-indenter.

Partner–University of Michigan Progress through Partnerships

In February 1896, just months after the German physicist Wilhelm Rontgen produced and detected electromagnetic radiation in a wavelength known today as x-rays, noted French scientist Henri Becquerel posited that phosphorescent materials such as uranium salts might also emit penetrating x-ray-like radiation when illuminated by bright sunlight. A number of experiments proved that theory incorrect, but led to an even more exciting discovery. The penetrating radiation came from the uranium itself, without any need of excitation by an external energy source. Becquerel had discovered spontaneous radioactivity.

During the intense research that followed, three other radioactive elements – thorium, polonium and radium – were discovered, the latter two by Becquerel’s doctoral student Marie Curie and her husband, Pierre. For their efforts, the three shared the 1903 Nobel Prize in Physics.

The University of Michigan (UM) was nearly 100 years old when Becquerel’s discovery came to light. And though it would be another half-century before the many fields of study that have grown out of his epiphany would evolve into what we now call nuclear science, the importance of the student role in the process was not lost on its leaders. In fact, it is one of the guiding principles that led the UM to establish the nation’s first graduate program in nuclear engineering.

The youngest of the engineering professions, housed in their Department of Nuclear Engineering and Radiological Sciences (NERS), is primarily concerned with the technological uses of radioactive materials and how they can be developed for public access. Applications such as the extraction of useful energy from atoms, the manufacture and safe handling of the numerous radioactive isotopes used in industry, and the development of new instruments and scanners to detect and image radiation are just a few of the areas in which UM graduate students seek a better understanding. All together they support an industry which contributes roughly 4.1 million jobs and some \$300 billion a year to the U.S. economy.

“Our NERS program has been ranked number one in the country for the last two years by the College of Engineering Graduate Program Rankings,” says Dr. Gary Was, professor of nuclear engineering and radiological sciences at the UM. “It began in the early 1950’s, then took on other graduate programs in the late 60’s. Today we have about 140 undergraduates, 100 graduate students

and about 29 faculty.” A few years back, Dr. Was and a number of colleagues took part in discussions with the Idaho National Laboratory (INL) about how to create new facilities, many of which have recently been installed, that would allow more people to work with irradiated materials. It became readily apparent that using a single location for all the irradiations, characterizations and examinations that could be done was simply not a workable option. The conversation quickly shifted to the many satellite facilities around the country which had some of the same capabilities. The idea of partnering with these universities and laboratories to expand the amount of research being done in the nuclear arena was eagerly adopted. The UM’s ion beam laboratory and their irradiated materials complex complement the mission of the ATR NSUF, and they were invited to join.

“We’ve been a partner facility for about three years now,” says Dr. Was proudly. “It’s been really beneficial for a number of reasons. For one, it doesn’t cost a lot to use our

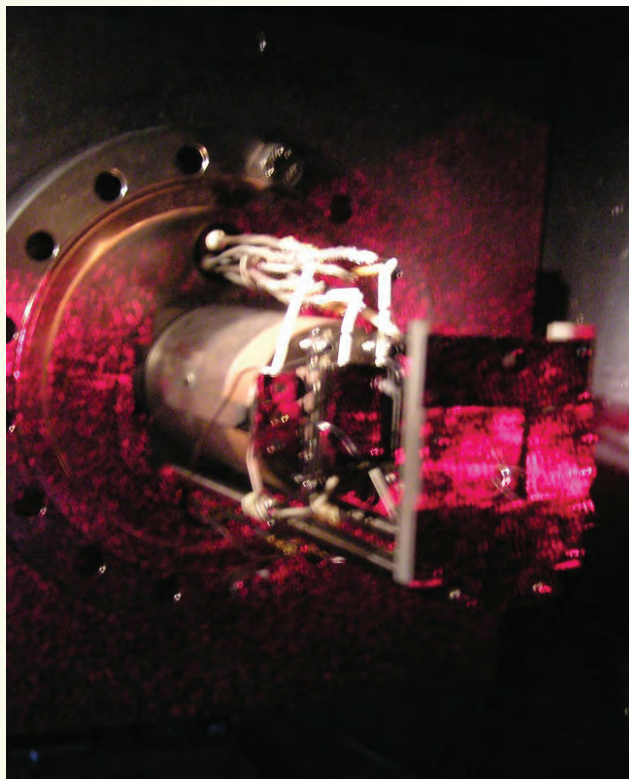

Laser alignment procedure for the samples that will be irradiated.

facilities. Also, I've frequently been able to help people produce experiments they may not have been able to do without the partnership program. Finally, it puts people in touch with one another to exchange information and collaborate in ways we probably would not otherwise be able to accomplish."

The UM has a strong and growing activity in radiant materials for nuclear systems and radiation effects. Four researchers in the ion beam lab and two more in the irradiated materials complex have all or part of their research focused in that area. One of their projects has created a collaboration with Boise State University and

the University of Wisconsin, both of whom have similar projects studying fission product transport through silicon carbide; the fuel capsule for the very high temperature gas reactor at the ATR.

"Having three universities all working on a similar topic together is really quite unique," Dr. Was says with a smile, "and it's exactly what this partnership is all about."

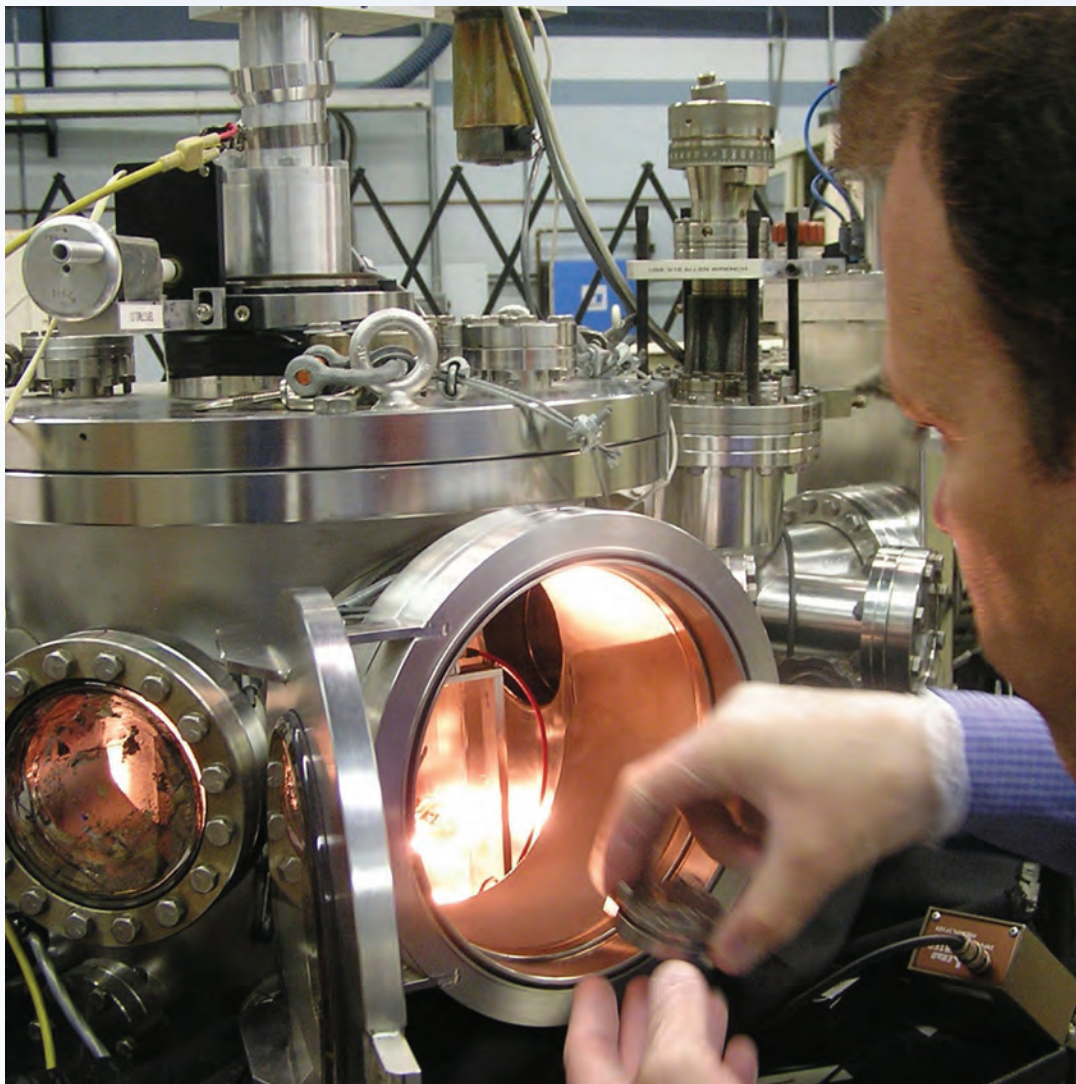

Surface analysis experiments at Michigan Ion Beam Laboratory: loading the samples.

Partner—University of Nevada, Las Vegas Rebel School Advances Nuclear Science

In 1951, when the post-war boom had swollen the population of metropolitan Las Vegas to more than 50,000, the University of Nevada, Reno, established an extension program in its sister city to the south. It began with 28 students attending classes held in the dressing rooms of the local high school auditorium. But it was an idea whose time had come. A short, six years later, fall classes opened on a new, 80-acre campus popularly known as Nevada Southern.

Over the next three decades, more than 100 buildings were erected on the burgeoning campus, dozens of academic programs were developed, and partnerships were created with the community. And the name grew, too. Adopting the Rebel as a symbol of its fierce desire to gain independence from Reno, the school began granting their own degrees in 1964, and the following year changed its name to Nevada Southern University.

In 1969 the state's board of regents approved another name change, this time to the University of Nevada, Las Vegas (UNLV), and by the 1977-78 academic year UNLV had surpassed its northern counterpart in total enrollment.

Today, more than 1,000 full-time faculty members teach more than 28,000 students, including 6,000 graduate and professional program students. Now sprawling across

350 acres, the university includes campuses specializing in biotechnology, dental medicine, and research and technology. The most recent addition to this prestigious list of curricula came in 2004, when the radiochemistry Ph.D. program was established to provide crucial resources for UNLV's Nuclear Science and Engineering program.

It has since become a premiere academic and research entity, recognized by DOE and national laboratories for its current research efforts that combine experiments with computations and modeling focusing on the structure, coordination and fundamental behavior of radioelements in solid and liquid phases. The ATR NSUF is proud to count UNLV as one of its newest partner institutions, and one that has the potential to develop into a national center of excellence.

"Part of my job as a research faculty member is collecting my own research money," explains Dr. Thomas Hartmann, Nuclear Engineering Research Professor at UNLV. "Most of my current, funded research is linked to programmatic research going on at the INL's MFC, so joining the ATR NSUF as a partner seemed like a natural thing to do."

"Radiochemistry research at UNLV is broadly divided into three main areas: solid phase synthesis and



UNLV's Science and Engineering Building.



Research Assistant Ariana Alaniz using the high-resolution powder x-ray diffractometer.

characterization, nuclear fuel cycle separations, and radioanalytical methods,” explains Dr. Hartmann. “The common thread is the use of microscopy, photon scattering, mass spectroscopy and radioanalytical techniques in the investigation of radioelement-containing solids.”

The Nuclear Technology Program was begun in 2001, when seven dedicated radiochemistry laboratories, occupying over 4,000 square feet, were developed in the Harry Reid Center for Environmental Studies to support experimental work with radioactive materials. The multidisciplinary team that runs these facilities combines extensive expertise in areas such as nuclear engineering, radioactive waste management, radiochemistry, medical isotopes and transmission electron microscopy, among others. An additional 5,000 square feet of laboratory space was added in 2009 with the opening of the new Science and Engineering Building.

“This partnership provides ATR NSUF with the possibility to outsource aspects of fundamentals to an

academic institution which can act more flexibly and cost-effectively,” says Dr. Hartmann. “This, in turn, provides research grants for students from undergraduates to post doctorate levels and will train the future work force for the national programs.”

The philosophy of working with other institutions to combine equipment, expertise, and knowledge, promises to reap benefits not only for the ATR NSUF and its partners, but for the field of nuclear science as a whole. And that translates to a better, safer world of energy for you and me.

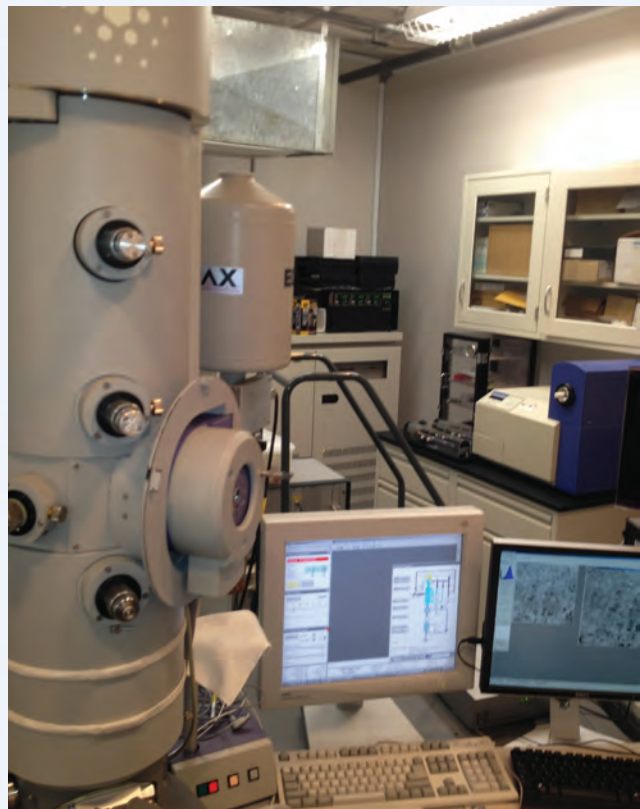

Transmission electron microscope (TEM) in the Science and Engineering Building.

Partner—University of Wisconsin Scientific Excellence in Action

In 1907, Stephen Babcock and Edwin Hart, two chemists in the University of Wisconsin's (UW) agricultural chemistry department, began a four-year project known as the Single-Grain Experiment. Their goal was to determine what effect limiting a cow's diet to only one grain like corn, wheat, or barley would have on the animal's health.

To make a long story short, much to the surprise of the agricultural community, which had originally scoffed at the idea, the chemists' work would lead to the establishment of nutrition as a recognized science and the realization that food contains vitamins and minerals.

Living up to scientific traditions like the one professors Babcock and Hart helped establish is one reason the University of Wisconsin is recognized as one of the leading research facilities in the United States. In fact, in the 2010 edition of its respected Academic Ranking of World Universities, Shanghai Jiao Tong University of Shanghai, China, ranked UW 17th among universities worldwide for its academic and research performance.

One of the focal points of this stellar reputation is the Materials Science Center (MSC) in the school's Department of Materials Science and Engineering, where a number of the projects described in this annual report take place.

In fact, in an example of how science comes full circle, several scientists from several research institutions are using the MSC's Characterization Laboratory for Irradiated Materials (CLIM) to study the effects of irradiation on the nanometer-sized "grains" that make up all metals and ceramics. Their goal is to create the advanced materials that can withstand the very high temperatures and radiation levels nuclear reactors of the future will generate. "Much of our work pertains to the lifetime properties of first-wall and fuel cladding materials," notes Dr. Jon McCarthy, the director of the MSC, "which is very important for the next generation of nuclear plants, especially gas-cooled reactors."

The MSC's superior equipment, staff and facilities are utilized by scientists from all over the world, and are a key reason the ATR NSUF approached the UW about forming a research partnership.

"We're expanding our CLIM capability significantly," Dr. McCarthy points out. "Our new high-current TORVIS source in the accelerator lab will increase the amount of hydrogen or helium current we can place on samples from the tandem accelerator. For researchers, this means shorter irradiation times and increased analytical sensitivity."

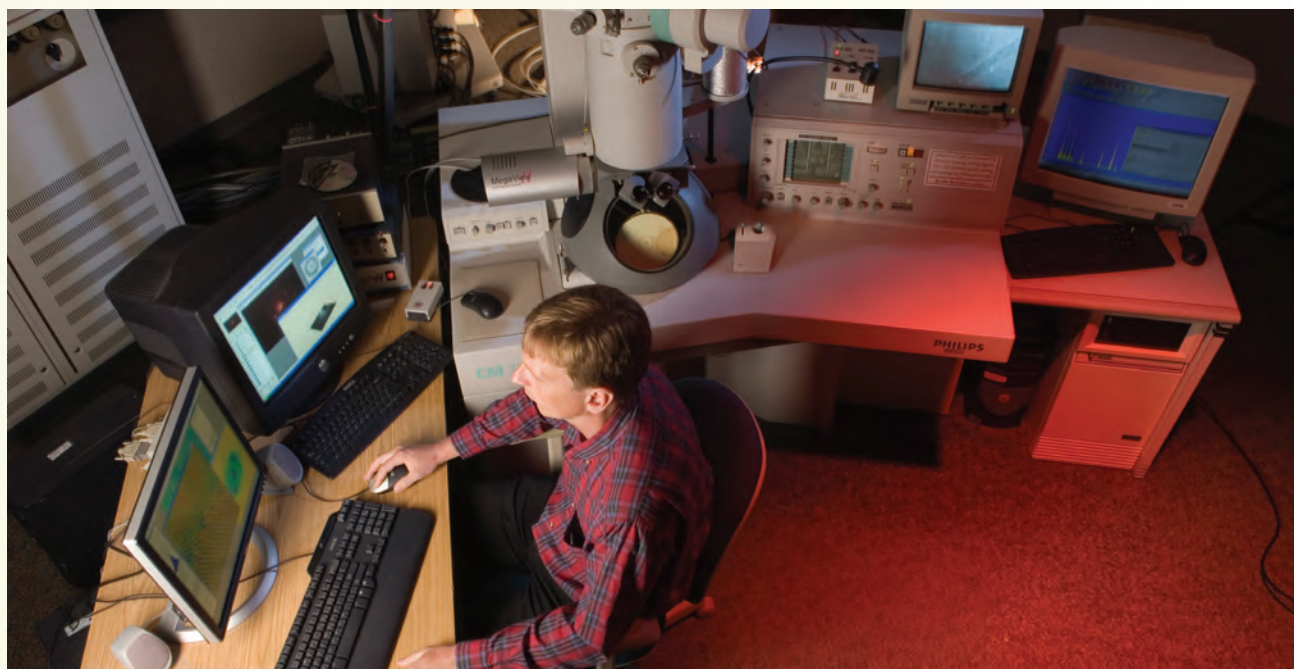

The high-resolution CM200 TEM with a new double-tilt holder for "hot" samples."

Other equipment upgrades the MSC is undertaking include:

- A new holder for irradiated samples will be added to the high-resolution CM200 transmission electron microscope (TEM). Resolution in the images from the CM200 will be doubled to 0.14 nm, as compared to the JEOL 200CX in the CLIM, and the double-tilt holder will also allow researchers to look at multiple zone axes for phase identification and contrast enhancement.
- An electron backscattering detector (EBSD) will be added to the JEOL 6610 scanning electron microscope (SEM) to allow researchers to compare changes in crystal grain size and orientation before and after irradiation under high-temperature conditions. Previously, obtaining this data through TEM examination required much more sample preparation



The Materials Science Center and Engineering Research building.

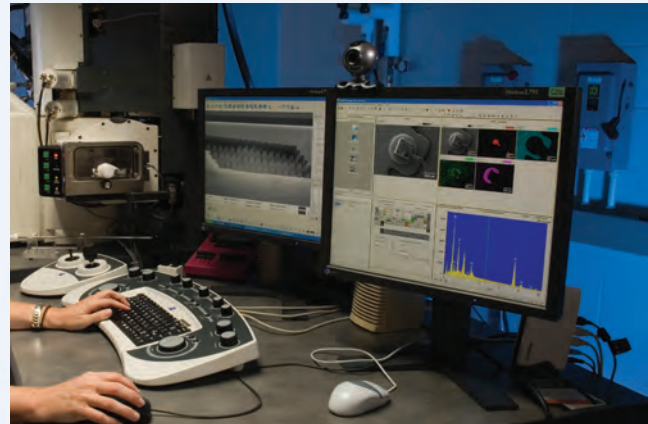

The focused ion beam produces sharp, clear images of 3-dimensional 20um cubes of materials.

and only yielded information from a very small area. EBSD can cover areas the size of square millimeters, versus the square nanometers current TEM technology is limited to, and in much less time.

- The existing JEOL 6610 SEM was moved to the reactor lab basement, dramatically reducing the effect of building vibrations and improving the maximum available magnification from 30,000X to 100,000X, meaning it can now be used for fine-grained materials.

As exciting as these new equipment developments are, Dr. McCarthy gets almost giddy when talking about the MSC's existing focused ion beam (FIB). "Even more exciting," he says, "is that we're using our current FIB/SEM to make 3-D images of a 20um-by-20um-by-20um cube of materials. We can see how dislocations and voids are related in space. Now that's very useful."

But like the research performed at each one of the ATR NSUF's partners, the work done at UW's Materials Science Center is more than just useful; it's important on several levels. "Technologically, providing the means to build more secure, high-power compact nuclear power plants that produce less radioactive waste has obvious safety benefits to the industry, the U.S. and the world," Dr. McCarthy says.

"Economically, the work we do here will help decrease our country's dependence on fossil fuels and foreign sources of oil. And, finally, environmentally, it can help protect our shores from more massive oil spills like the one that devastated the Gulf Coast."

ATR NSUF –Program Information



ATR NSUF users at work.



Program Overview

ATR NSUF: A New Model for Collaboration

ATR NSUF and its partner facilities represent a prototype laboratory for the future. This unique model is best described as a distributed partnership with each facility bringing exceptional capabilities to the relationship including reactors, beamlines, state-of-the-art instruments, hot cells, and most importantly, expert mentors. Together these capabilities and people create a nation-wide infrastructure that allows the best ideas to be proven using the most advanced capabilities. Through ATR NSUF, university researchers and their collaborators are building on current knowledge to better understand the complex behavior of materials and fuels in the radiation environment of a nuclear reactor.

Since ATR NSUF established the partnership program, seven universities and one national laboratory have offered their facilities' capabilities, greatly expanding the kinds of research that can be offered. The avenues opened through these partnerships facilitate cooperative research across the country, matching people with capabilities, students with mentors. As new partners join ATR NSUF, research opportunities will expand into new areas such as thermal hydraulics and advanced modeling.

In 2011, ATR NSUF included INL and the following institutions:

- Illinois Institute of Technology
- Massachusetts Institute of Technology
- North Carolina State University
- Oak Ridge National Laboratory
- University of California, Berkeley
- University of Michigan
- University of Nevada, Las Vegas
- University of Wisconsin

In the pages that follow, you will read specific details on the capabilities of the ATR NSUF and its partners. You will also learn how to access these capabilities through the calls for proposals. ATR NSUF hosts a yearly Users Week designed to instruct and inform. This week is free of charge to interested persons, and a number of scholarships for travel and hotel are offered to students and faculty. ATR NSUF also offers educational opportunities such as internships and faculty/student research teams.

We hope you take time to familiarize yourself with the many opportunities offered by ATR NSUF, and consider submitting a proposal or two!



Frances Marshall presenting an overview of the Advanced Test Reactor at the 2011 Users Week Introductory Workshop.



U.S. DEPARTMENT OF
ENERGY

Nuclear Energy

ATR NSUF Research Supports DOE-NE Missions

The Department of Energy (DOE) Office of Nuclear Energy (NE) organizes its research and development activities based on four main objectives that address challenges to expanding the use of nuclear power:

- Develop technologies and other solutions that can improve the reliability, sustain the safety and extend the life of current reactors
- Develop improvements in the affordability of new reactors to enable nuclear energy to help meet the Administration's energy security and climate change goals
- Develop sustainable nuclear fuel cycles
- Understand and minimize the risks of nuclear proliferation and terrorism.

ATR NSUF research addresses a number of these mission needs. Most of the research contained in this report looks at either understanding the mechanisms of radiation on materials and fuels to address the challenges of the aging current fleet, or looks at materials and fuels for the next generation of reactors. To be eligible as an ATR NSUF research project, the research must support at least one of the DOE-NE missions. For specific information on DOE missions, please check out the following link: <http://www.ne.doe.gov>.

To learn more about proposing a research project, please visit the ATR NSUF website at: <http://atrnuf.inl.gov>.

Reactor Capabilities

The ATR NSUF offers access to a number of reactors. The ATR is located at the ATR Complex on the INL Site and has been operating continuously since 1967. In recent years, the reactor has been used for a wide variety of government and privately sponsored research. The ATR-C reactor is low power version of the ATR.

The MIT reactor is a 5 MW reactor with positions for in-core fuels and materials experiments. ORNL's High

Flux Isotope Reactor (HFIR) is an 85 MW reactor offering steady-state neutron flux and a variety of experiment positions. The PULSTAR reactor at North Carolina State University is a pool-type reactor that offers response characteristics similar to commercial light water power reactors.

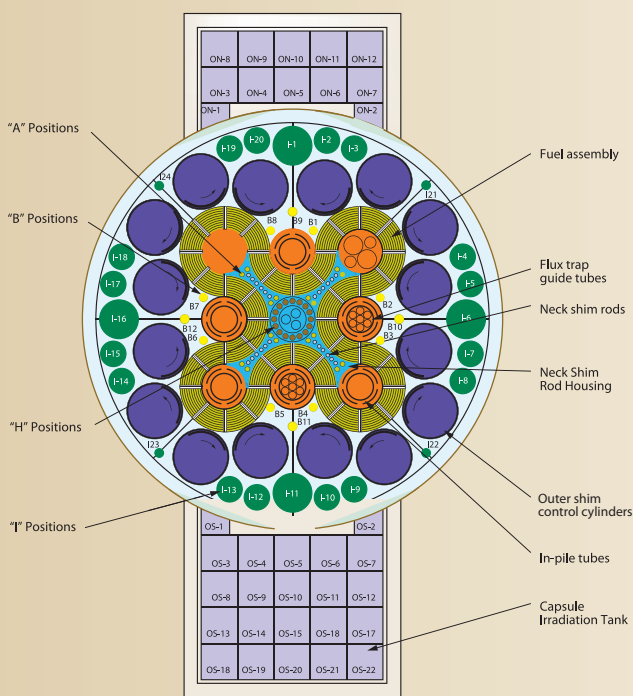

ATR's serpentine design allows a variety of experiment configurations.

Idaho National Laboratory: Advanced Test Reactor

The ATR is a water-cooled, high-flux test reactor, with a unique serpentine design that allows large power variations among its flux traps. The reactor's curved fuel arrangement places fuel closer on all sides of the flux trap positions than is possible in a rectangular grid. The reactor has nine of these high-intensity neutron flux traps and 68 additional irradiation positions inside the reactor core reflector tank, each of which can contain multiple experiments. Experiment positions vary in size from 0.5" to 5.0" in diameter and all are 48" long. The peak thermal flux is 1×10^{15} n/cm²-sec and fast flux is 5×10 n/cm²-sec when operating at full power of 250 MW. There is a hydraulic shuttle irradiation system, which allows experiments to be inserted and removed during reactor operation, and pressurized water reactor (PWR) loops, which enable tests to be performed at prototypical PWR operating conditions.

More information: <http://atrnusuf.inl.gov/Capabilities/Reactors/INLAdvancedTestReactor/ATRUUsersGuide/tabid/106/Default>

Idaho National Laboratory: Advanced Test Reactor Critical Facility

The ATRC is a low-power version (same size and geometry) of the higher-powered ATR core. It is operated at power levels less than 5 KW with typical operating power levels of 600 W or less. ATRC is primarily used to provide data for the design and safe operation of experiments for the ATR. ATRC is also used to supply core performance data for the restart of the ATR after periodic core internals replacement. Occasionally the ATRC is used to perform low-power irradiation of experiments.

More information: <http://atrnusuf.inl.gov/Capabilities/Reactors/INLAdvancedTestReactor/ATRCUsersGuide/tabid/173/Default>

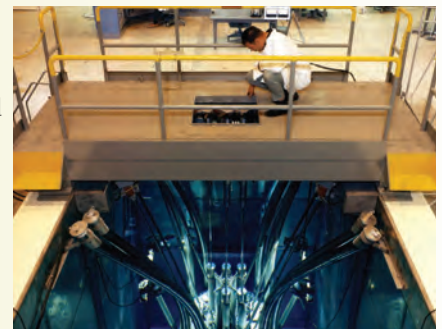

Aerial view of the ATRC reactor core and bridge.

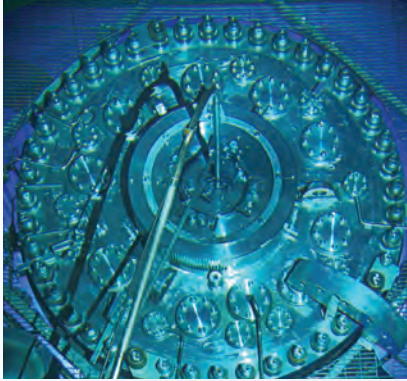

Top of the HFIR reactor.

Oak Ridge National Laboratory High Flux Isotope Reactor

HFIR is a versatile 85 MW research reactor offering the highest steady-state neutron flux in the western world. With a peak thermal flux of 2.5×10^{15} n/cm²-s and a peak fast flux of 1.1×10^{15} n/cm²-s, HFIR is able to quickly generate isotopes that require multiple neutron captures and perform materials irradiations that simulate lifetimes of power reactor use in a fraction of the time. HFIR typically operates 7 cycles per year, each cycle lasting between 23 and 26 days. Associated irradiation processing facilities include the Hydraulic Tube Facility, Pneumatic Tube Facilities for Neutron Activation Analysis (NAA), and Gamma Irradiation Facility.

More information: <http://atrnsof.inl.gov/Capabilities/Reactors/ORNLFIRReactor/tabid/196/Default.aspx>



(above) MIT reactor facility in Cambridge, Massachusetts. (left) Annular fuel rig in the MITR core.

Massachusetts Institute of Technology Reactor

The MITR is a 5 MW tank-type research reactor. It has three positions available for in-core fuel and materials experiments over a wide range of conditions. Water loops at pressurized water reactor/boiling water reactor (PWR/BWR) conditions, high-temperature gas reactor environments at temperatures up to 1400°C and fuel tests at light water reactor (LWR) temperatures have been operated and custom conditions can also be provided. A variety of instrumentation and support facilities are available. Fast and thermal neutron fluxes are up to 10^{14} and 5×10^{14} n/cm²-s. The MITR has received approval from the Nuclear Regulatory Commission for a power increase to 6 MW which will enhance the neutron fluxes by 20%.

More information: <http://atrnsof.inl.gov/Capabilities/Reactors/MITReactor/MITRUsersGuide/tabid/127/Default.aspx>

North Carolina State University PULSTAR Reactor

The PULSTAR reactor is a 1 MW pool-type nuclear research reactor located in NCSU's Burlington Engineering Laboratories. The reactor, one of two PULSTAR reactors built and the only one still in operation, uses 4% enriched, pin-type fuel consisting of uranium dioxide pellets in zircaloy cladding. The fuel provides response characteristics that are very similar to commercial light water power reactors. These characteristics allow teaching experiments to measure moderator temperature and power reactivity coefficients including Doppler feedback. In 2007, the PULSTAR reactor produced the most intense low-energy positron beam with the highest positron rate of any comparable facility worldwide.

More information: <https://secure.inl.gov/atproposal/documents/PULSTARReactor.pdf>

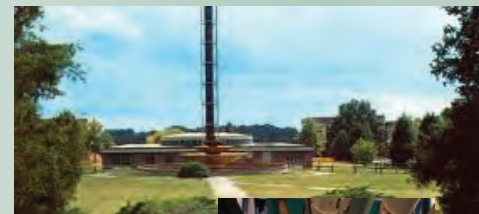

(above) PULSTAR reactor facility on the NCSU North Campus in Raleigh, North Carolina. (right) Downward view of the PULSTAR reactor pool.

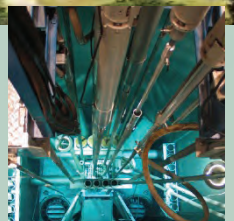

Post-irradiation Examination Capabilities

ATR NSUF offers researchers access to a broad range of post-irradiation examination facilities.

Included in 2011 are capabilities at INL's Materials and Fuels Complex; the Nuclear Services Laboratories at North Carolina State University; hot cells and radiological laboratories at Oak Ridge National Laboratory; several in-

struments from the Nuclear Materials Laboratory at University of California, Berkeley; the Irradiated Materials Complex at the University of Michigan; the Harry Reid Center Radiochemistry Laboratories at the University of Nevada, Las Vegas; and the Characterization Laboratory for Irradiated Materials at the University of Wisconsin.

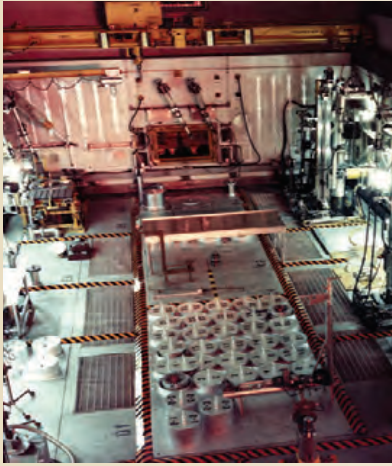

Hot Fuel Examination Facility, located at the Materials and Fuels Complex at DOE's INL site in Idaho.

Idaho National Laboratory: Hot Fuel Examination Facility Analytical Laboratory, Electron Microscopy Laboratory

HFEF is a large alpha-gamma hot cell facility dedicated to remote examination of highly irradiated fuel and structural materials. Its capabilities include nondestructive and destructive examinations. The facility also offers a 250 kWth Training Research Isotope General Atomics (TRIGA) reactor used for neutron radiography to examine internal features of fuel elements and assemblies.

The Analytical Laboratory is dedicated to analytical chemistry of irradiated and radioactive materials. It offers National Institute of Science and Technology (NIST)-traceable chemical and isotopic analysis of irradiated fuel and material via a wide range of spectrometric techniques.

The Electron Microscopy Laboratory (EML) is dedicated to materials characterization, primarily using transmission electron, scanning electron and optical microscopy. The EML also houses a dual-beam FIB that allows examination and small-sample preparation of radioactive materials.

More information: <https://secure.inl.gov/atrproposal/documents/PIECapabilities-Guide.pdf>

North Carolina State University Nuclear Services Laboratories

Post-irradiation examination capabilities at NCSU's Nuclear Services Laboratories include neutron activation analysis, radiography and imaging capabilities, and positron spectrometry.

More information: <https://secure.inl.gov/atrproposal/documents/PULSTARReactor.pdf>

Technicians work at hot cells in the Irradiated Fuels Examination Laboratory (IFEL).

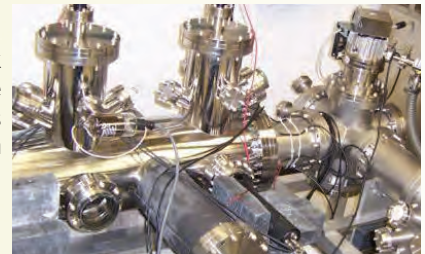

Technicians work at hot cells in the Irradiated Fuels Examination Laboratory (IFEL).

Oak Ridge National Laboratory Hot Cells & Radiological Laboratories

ORNL hot cells and radiological laboratories offer a wide variety of R&D and production capabilities from radiochemistry and isotope packaging to materials testing to irradiated fuels examination. Facilities include the Irradiated Materials Examination and Testing (IMET) facility, Irradiated Fuels Examination Laboratory (IFEL), and Radiochemical Engineering Development Center (REDC).

More information: http://atrnsof.inl.gov/Portals/0/UserGuides/ORNL-NSUF%20Post%20Irradiation%20Facilities_1.1.pdf

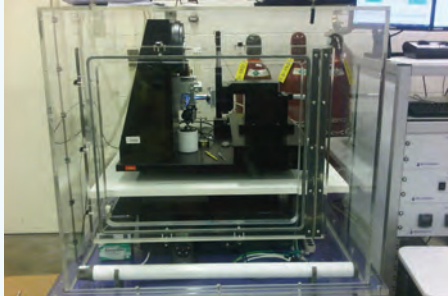

UC Berkeley nano-indentation system.

University of California, Berkeley Nuclear Materials Laboratory

UC Berkeley provides several capabilities for examining irradiated material samples including a nano-indentation system for nano and microscale hardness testing at ambient and elevated temperature and inert environments, positron annihilation spectroscopy, and warm sample preparation (polishing, cutting, grinding, and mounting).

More information: <https://secure.inl.gov/atrproposal/documents/UCBerkeleyPIF.pdf>



Capabilities at the Irradiated Materials Complex on the UM campus at Ann Arbor, Michigan.

University of Michigan Irradiated Materials Complex

The Irradiated Materials Complex provides capabilities (laboratories and hot cells) for conducting high-temperature mechanical properties, and corrosion and stress corrosion cracking experiments on neutron irradiated materials in an aqueous environment, including supercritical water, and for characterizing the fracture surfaces after failure.

More information: <https://secure.inl.gov/atrproposal/documents/UniversityofMichiganIMCandMIBLFacilities.pdf>

University of Nevada, Las Vegas Harry Reid Center Radiochemistry Laboratories

Post-irradiation examination capabilities at the Radiochemistry Laboratories include metallographic microscopy, X-ray powder diffraction, Rietveld analysis, scanning electron and transmission electron microscopy, electron probe microanalysis, and X-ray fluorescence spectrometry.

More information: <https://secure.inl.gov/atrproposal/documents/UNLVPartner-FacilityUserGuide.pdf>

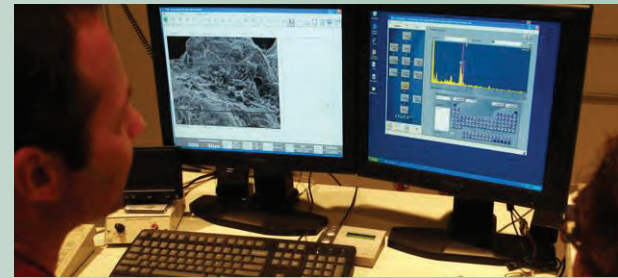

Post-irradiation examination capabilities at the Harry Reid Center Radiochemistry Laboratories, located on the UNLV campus in Las Vegas, Nevada.



A JEOL 200CX TEM equipped with EDS and scanning system, and an electro-polisher and dimpler at the Characterization Laboratory for Irradiated Materials, located on the UW campus in Madison, Wisconsin.

University of Wisconsin Characterization Laboratory for Irradiated Materials

The Characterization Laboratory for Irradiated Materials offers post-irradiation examination capabilities including scanning electron and transmission electron microscopy on neutron-irradiated materials.

More information: <https://secure.inl.gov/atrproposal/documents/UniversityofWisconsinCLIMGuide.pdf>

Beamline Capabilities

The ATR NSUF offers researchers access to a broad range of facilities with beamlines, including accelerator facilities for radiation damage experiments, synchrotron radiation studies, neutron diffraction and imaging, as well as positron and neutron activation analysis.

In 2011, the ATR NSUF program offered researchers access to four university partner beamline facilities. These

include the Illinois Institute of Technology Materials Research Collaborative Access Team (MRCAT) beamline at Argonne's Advanced Photon Source, the PULSTAR reactor facility at North Carolina State University, the University of Michigan Ion Beam Laboratory, and the University of Wisconsin Tandem Accelerator Ion Beam.



Aerial view of the Advanced Photon Source at Argonne National Laboratory, located in Argonne, Illinois.

Illinois Institute of Technology (IIT) MRCAT at Argonne National Laboratory's Advanced Photon Source

The Materials Research Collaborative Access Team (MRCAT) beamline offers a wide array of synchrotron radiation experiment capabilities, including x-ray diffraction, x-ray absorption, x-ray fluorescence and 5 μm spot size fluorescence microscopy.

More information: <https://secure.inl.gov/atrproposal/documents/Advanced-PhotonSource.pdf>

North Carolina State University PULSTAR Reactor Facility

The PULSTAR reactor facility offers a selection of dedicated irradiation beam port facilities — neutron powder diffraction, neutron imaging, intense positron source and ultra-cold neutron source. An intense positron source has been developed to supply a high-rate positron beam to two different positron/positronium annihilation lifetime spectrometers.

More information: <https://secure.inl.gov/atrproposal/documents/PULSTARReactor.pdf>

Positron beam cave containing magnetic switchyards and transport solenoids, located in the PULSTAR reactor facility on the NC State North Campus in Raleigh,



University of Michigan Michigan Ion Beam Laboratory

The 1.7 MV Tandetron accelerator in the Michigan Ion Beam Laboratory offers controlled temperature proton irradiation capabilities with energies up to 3.4 MeV as well as heavy ion irradiation.

More information: <https://secure.inl.gov/atrproposal/documents/UniversityofMichiganIMCandMIBLFacilities.pdf>

Michigan Ion Beam Laboratory for Surface Modification and Analysis, located on the UM campus in Ann Arbor, Michigan.

University of Wisconsin Tandem Accelerator Ion Beam

A 1.7 MV terminal voltage tandem ion accelerator (Model 5SDH-4, National Electrostatics Corporation Pelletron accelerator) installed at UW features dual ion sources for producing negative ions with a sputtering source or using a radio frequency (RF) plasma source. The analysis beamline is capable of elastic recoil detection and nuclear reaction analysis.

More information: <https://secure.inl.gov/atrproposal/documents/UniversityofWisconsinCLIMGuide.pdf>

Tandem Ion Beam Accelerator, located on the UW campus in Madison, Wisconsin.



Calls for Proposals



Frances Marshall
Manager, Program Operations

Mary Catherine Thelen
Program Administrator



Calls for Proposals

The ATR NSUF mission is to provide nuclear energy researchers access to world-class capabilities to facilitate the advancement of nuclear science and technology. This mission is supported by providing cost-free access to state-of-the-art experimental irradiation testing and post-irradiation examination facilities as well as technical assistance in design and analysis of reactor experiments. Access is granted through a competitive proposal process.

ATR NSUF offers two research proposal options (described in more detail below) through an online submittal system that helps prospective researchers develop, edit, review, and submit their proposals. ATR NSUF staff is available to help any researcher submit a proposal.

Submitted proposals should be consistent with the DOE-NE mission and its programmatic interests. These interests included the Light Water Reactor Sustainability, Fuel Cycle Research and Development, Advanced Modeling and Simulation, and Generation IV Nuclear Energy Systems.

All proposals are subject to a peer-review process before selection. An accredited U.S. university or college must lead research proposals for irradiation and post-irradiation examination only experiments. Collaborations with other national laboratories, federal agencies, non-U.S. universities and industries are encouraged.

Any U.S.-based entities, including universities, national laboratories and industry can propose research that would utilize the Materials Research Collaborative Access Team (MRCAT) beamline at the Advanced Photon Source or would be conducted as a Rapid-Turnaround Experiment.

Calls for Irradiation, Post-Irradiation Examination and MRCAT Experiments

The ATR NSUF annually conducts two open calls for proposals. The first is the fall call, which is aligned with the Nuclear Energy University Program (NEUP) call. This alignment allows proposers who require both NEUP

funding and ATR NSUF capabilities to propose only once, to the joint NEUP/ATR NSUF call. For proposers who only want access to ATR NSUF capabilities the call opens in July and closes in January. Awards are made at the same time as NEUP awards, and therefore the award date is subject to change. ATR NSUF also offers a spring/summer call that opens in late January and closes in early July. Award for this call are typically made in late October or early November. Proposals for the open calls are accepted for:

- Irradiation and post-irradiation examination of materials or fuels
- Post-irradiation examination of previously irradiated materials or fuels from the ATR NSUF sample library (described below)
- Research that requires the unique capabilities of the Advanced Photon Source through the MRCAT beamline, operated by the Illinois Institute of Technology.

All proposals submitted to the open calls undergo thorough reviews for feasibility, technical merit, relevance to DOE-NE missions and cost. Proposals submitted to the joint NEUP/ATR NSUF call undergo reviews in accordance with NEUP guidance. The results for proposals requiring ATR NSUF capability are compiled and provided to a panel committee who performs a final review and ranks the proposals. The ranking is given to the ATR NSUF scientific director. For the joint call, proposals must rank high in both the NEUP and ATR NSUF rankings. Awards allow users cost-free access to specific ATR NSUF and partner capabilities as determined by the program.

Calls for Rapid-Turnaround Experiments

Rapid-Turnaround Experiments are experiments that can be performed quickly — in two months or less — and include, but are not limited to, PIE, ion beam irradiation and neutron scattering experiments. Proposals for Rapid-

Turnaround Experiments are reviewed on a quarterly basis in January, April, July and October and awarded based on the following rankings:

- High Priority — Proposal is awarded immediately upon review if funding is available
- Recommended — Proposal is placed in a queue from which awards are made approximately every other month if funding is available
- Not Recommended — Proposal is not awarded, but the project investigators are offered an opportunity to read the review comments and then resubmit.

Visit the ATR NSUF online webpage for proposals at: <https://secure.inl.gov/atrproposal/Common/UserHome.aspx>

ATR NSUF Sample Library

ATR NSUF has also established a sample library as an additional pathway for research. The library contains irradiated and non-irradiated samples in a wide range of material types, from steel samples irradiated in fast reactors to ceramic materials irradiated in the Advanced Test Reactor. Many samples are from previous DOE-funded material and fuel development programs. University researchers can propose to analyze these samples in a PIE-only experiment. Samples from the library may be used for proposals for open calls and Rapid-Turnaround Experiments. As the ATR NSUF program continues to grow, so will the sample library. To review an online list of available specimens, visit the ATR NSUF electronic system at the address above.

Users Week



2011 Users Week tour at Hot Fuel Examination Facility.

The annual ATR NSUF Users Week offers researchers five full days of workshops, tours, discussions and classes. The focus is on providing an understanding of key nuclear technology gaps, capabilities required for addressing those gaps, recent or emerging advances, and techniques for conducting reactor experiments and post-irradiation examination.

Users Week is not just a way to learn more about ATR NSUF, its capabilities and ongoing research, it is also a great opportunity to meet other students, scientists and engineers who are interested in responding to the ATR NSUF's call for proposals. Users Week supports the ATR NSUF as a model for the laboratory of the future, where collaborative research and shared resources among universities and national laboratories will help prepare a new generation of nuclear energy professionals.

The week's events are free of charge for students, faculty and post-docs as well as researchers from industry and national laboratories who are interested in materials, fuels, post-irradiation examination and reactor-based technology development. In the four years since its inception, ATR NSUF Users Week has hosted 508 participants from 30 countries and 35 U.S. universities.

Scholarships to help defray travel, hotel and meal expenses are offered to university faculty and students on a competitive basis.



Touring the Advanced Test Reactor (ATR) during 2011 Users Week.

What to Expect at Users Week

Users Week kicks off with an introductory workshop to ATR NSUF, which includes a description of current and upcoming research capabilities offered by INL and its university partners, a briefing on the solicitation process and opportunities within the education program, and a welcome from DOE, usually delivered by an official from DOE headquarters.

Each year, Users Week offers a number of workshops and courses for students to participate in. These may vary from year to year, but courses generally focus on a variety of topic-specific areas, such as in-reactor instrumentation, fuels and materials, or how to conduct radiation experiments.

Participants are always offered an opportunity to tour the

ATR as well as INL's Materials and Fuels Complex where many post-irradiation examination facilities are housed.

An annual research forum was initiated in 2009, and is offered each year. The forum offers an opportunity for university, industry and national laboratory researchers to present their ATR NSUF sponsored research findings in a collaborative environment.

For more information about Users Week please visit the ATR NSUF website at: <http://atrnsuf.inl.gov>



Participants at 2011 Users Week Introductory Workshop.

Educational Programs and Opportunities

Jeff Benson
Education Coordinator

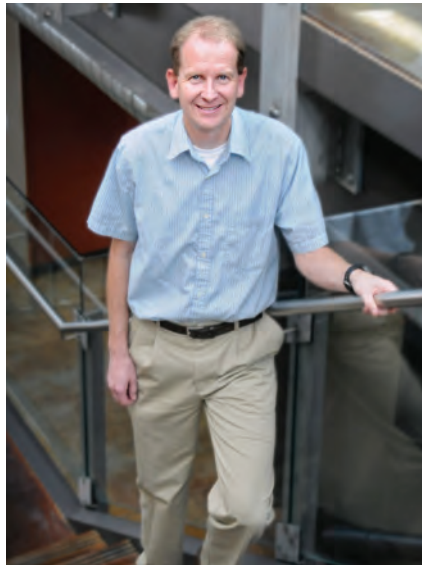

Faculty/Student Research Teams (FSRT)

This unique research opportunity provides faculty and students with a chance to spend part of a summer performing research in collaboration with an INL scientist or engineer. Projects are selected (depending on funding availability) through a special call for proposals, which is openly advertised and posted on the ATR NSUF website.

Proposals are accepted for scientifically meritorious projects that result in increased research capability for the ATR NSUF. Specific areas of interest include:

- Ramp testing of fuel
- Instrumentation test capsule design
- In-canal measurements
- Integrated computational modeling for analysis of irradiation experiments
- In-reactor ultrasonic measurement
- Analysis of materials using advanced techniques.



Photos of educational opportunities: (above) Touring Hot Fuel Examination Facility during Users Week. (opposite top) students at Users Week Introductory Workshop. (opposite bottom) students touring Electron Microscopy Laboratory.

Proposals should be designed to meet the following criteria:

- Project lead must be a faculty member from an accredited U.S. university
- Proposal must include at least two research participants, preferably graduate students
- Participants must commit to spend 10 to 12 weeks at INL, preferably during the summer
- Mutual agreement about the project must be reached by the faculty member and assigned INL researcher prior to arrival.

Proposals are generally submitted in January, reviewed, and funded in early summer through a subcontract to the university faculty project lead.

Graduate and Undergraduate Internships

Each year, a number of internships are offered through the ATR NSUF intern program. These internships are designed to provide students real-life experience in science or en-

gineering in a national laboratory setting and to introduce students to the issues and opportunities in nuclear operations, nuclear science and technology, and materials and fuels research. Graduate students may also use an internship to conduct thesis or dissertation research.

To learn more about educational opportunities visit the ATR NSUF website at: <http://atrnsof.inl.gov/Facultyand-Students/Internships/tabid/75/Default.aspx>



Distributed Partnership at a Glance

PIs/Users 

Partners

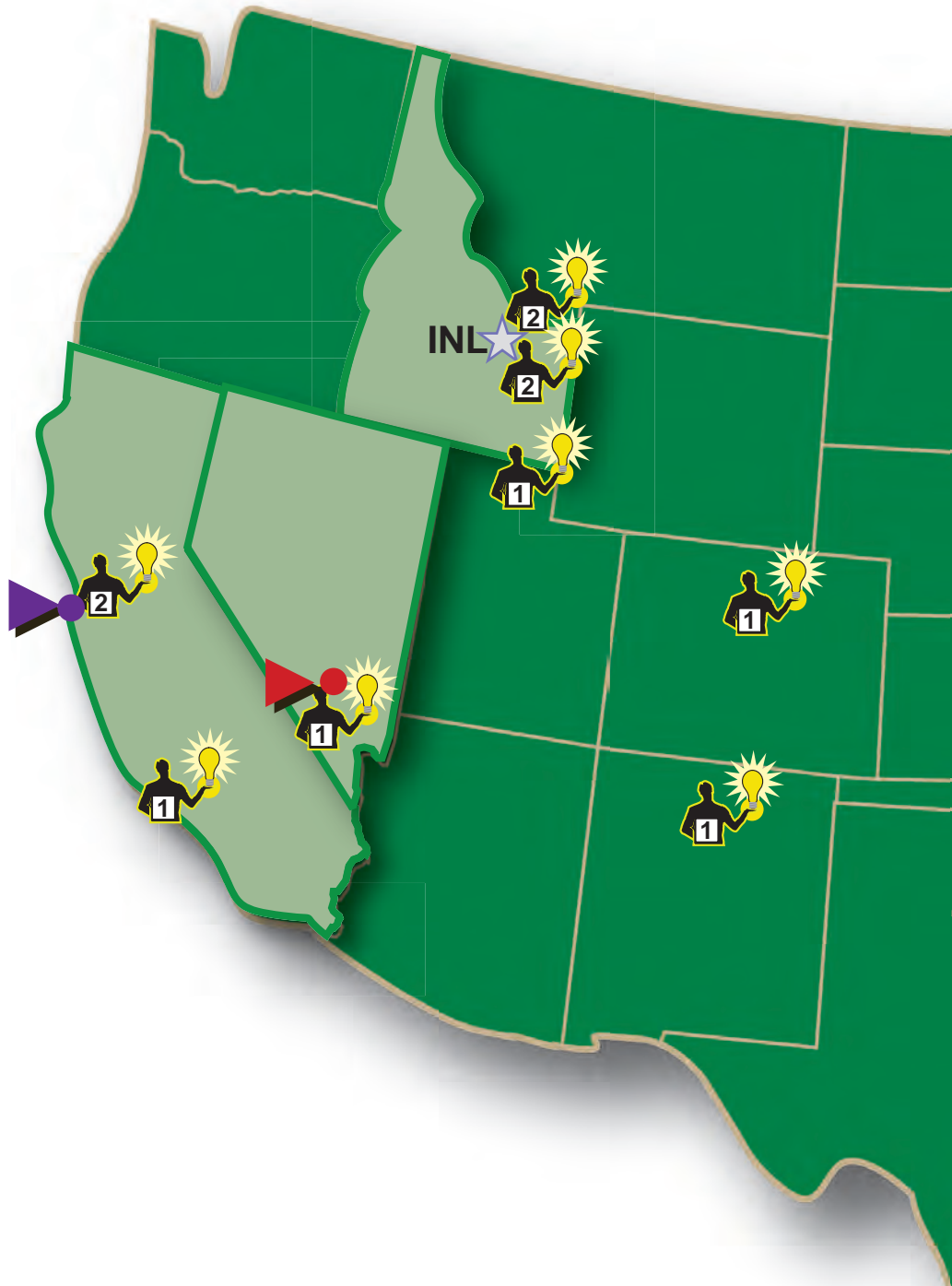



G12 2494-2067

Irradiation Effect on Thermophysical Properties of Hafnium-Aluminide Composite: A Concept for Fast Neutron Testing at the Advanced Test Reactor

Introduction

The capability to conduct fast neutron irradiation tests is essential to meet fuels and materials development requirements for future nuclear reactors. The lack of this capability domestically hinders the development of advanced reactors.

Results showed that the non-intuitive pressure drop observed in hydraulic flow experiments is due to the complex interaction between vortices and turbulence.

Project Description

The concept behind this project is to add both a thermal neutron filter to one of the corner lobes in the INL's ATR to absorb the thermal neutrons and booster fuel in order to augment the neutron flux. An absorber material comprised of hafnium aluminide (Al_3Hf) particles (~23% by volume) in an aluminum matrix ($\text{Al}_3\text{Hf-Al}$) absorbs thermal neutrons and transfers heat from the experiment to pressurized water cooling channels. Thermal analyses conducted on a candidate configuration confirmed that the design of the water-cooled $\text{Al}_3\text{Hf-Al}$ absorber block is capable of keeping all system components below their maximum allowable temperature limits.

However, the thermophysical properties of Al_3Hf have never been measured, and the effect of irradiation on these properties has never been determined. Therefore, before proceeding with the design and optimization, it is essential to obtain data on the effect of irradiation on both the Al_3Hf and the $\text{Al}_3\text{Hf-Al}$ composite, as well as information on corrosion behavior and radioactive decay products. This experiment is expected to determine the necessary properties and behaviors of this new material. Specific objectives are to determine:

The thermophysical and mechanical properties of Al_3Hf intermetallic and $\text{Al}_3\text{Hf-Al}$ composite at different temperatures.

The effect of irradiation on these properties, along with physical/morphological, metallurgical and microstructural changes in the $\text{Al}_3\text{Hf-Al}$ composite after different cycles of irradiation.

The corrosion behaviors of the composite and decay products of hafnium (Hf-179m1 versus Hf-179m2).



Figure 1. USU experiment material specimens.

Accomplishments

Material specimens were fabricated and inspected in accordance with INL's Quality Plan (Figure 1). Prior to irradiation, characterization of the specimens was performed to document their thermophysical properties. The experiment was inserted into the reactor and radiation commenced in April 2011, lasting for four cycles.

While the specimens were in the reactor, computational fluid dynamics simulations were performed on a novel hybrid capsule designed originally for use in this experiment. Results showed that the non-intuitive pressure drop observed in hydraulic flow experiments is due to the complex interaction of vortices and turbulence interactions (Figure 2). Although the hybrid capsule was deemed too immature for this irradiation campaign, the concept would be used for future capsule designs.

Future Activities

Irradiation is scheduled to be completed at the end of February 2012 at which time the capsules will be removed from ATR and sent to the Materials and Fuels Complex (MFC) for disassembly. At that time, they will also be

“Because of my work on this project, I have decided to get a nuclear engineering Ph.D. after my master’s degree.”

Adam Zabriskie, Graduate Student, Utah State University.

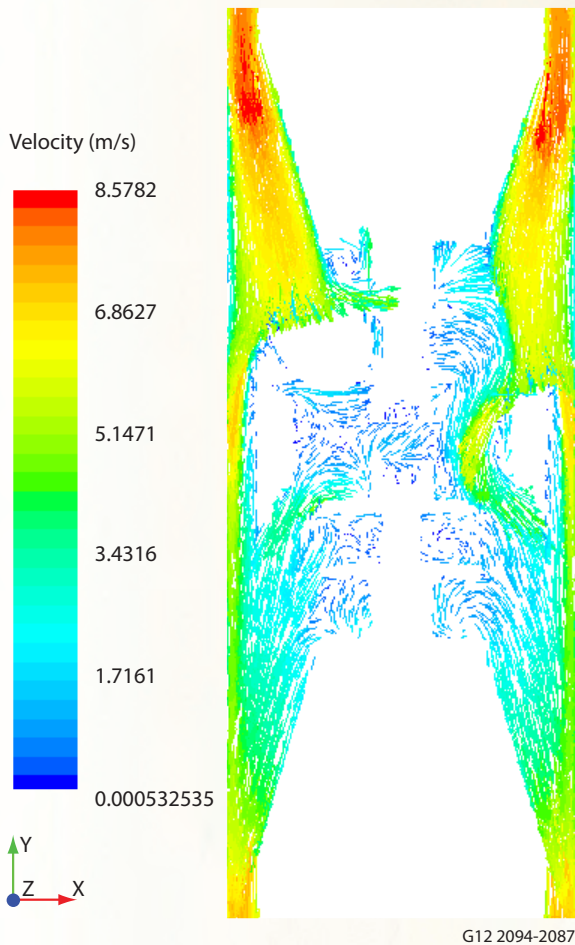

Figure 2. Velocity vectors in the z-normal plane of the hybrid capsule showing strong interactions between vortices that caused an increased pressure drop at a flow rate of 8 gpm.

characterized according to the post-irradiation examination (PIE) plan. The neutron flux wires will be removed from the hardware and sent to Pacific Northwest National Laboratory (PNNL) for analysis.

Tensile testing and transmission electron microscopy (TEM) is still needed for the unirradiated specimens. These examinations are scheduled to be performed at the MFC. As-run neutronic and thermal analyses are also needed so that the post-irradiation properties measured can be put in context

of the neutronic and thermal environment to which the specimens were subjected.

Publications & Presentations

1. D. P. Guillen, W.D. Swank, A.X. Zabriskie and H. Ban, “Prediction of Specimen Temperatures during Irradiation of a New Composite Material,” The 14th International Topical Meeting on Nuclear Reactor Thermal Hydraulics, NURETH14-108, Toronto, Ontario, Canada, September 25-29, 2011.
2. D. P. Guillen, B.P. Durtschi, A.X. Zabriskie and H. Ban, “Integrated Static and Flow-Through Capsule Assembly for Irradiation Testing,” *2011 Transactions of the American Nuclear Society*, 2011 American Nuclear Society Meeting, June 26-30, 2011.
3. D. P. Guillen, D.L. Porter, J.R. Parry, H. Ban, “In-Pile Experiment of a New Hafnium Aluminide Composite Material to Enable Fast Neutron Testing in the Advanced Test Reactor,” 2010 American Nuclear Society International Congress on Advances in Nuclear PowerPlants ICAPP 2010, Paper 10115, San Diego, CA, June 13-17, 2010.
4. H. Wampler, A. Gerth, H. Ban, D.P. Guillen, D.L. Porter, C. Papesch, and T. Hartmann, “Fabrication and Characterization of a Conduction Cooled Thermal Neutron Filter,” 2010 American Nuclear Society International Congress on Advances in Nuclear Power Plants ICAPP 2010, Paper 10118, San Diego, CA, June 13-17, 2010.

Patents Applied For

Attorney Docket No. 2939-10350US (BA-537), “Neutron Absorbers and Methods of Forming at Least a Portion of a Neutron Absorber,” filed May 24, 2011. Inventors: Donna Guillen, Doug Porter, Dave Swank and Arnie Erickson.

Distributed Partnership at a Glance
ATR NSUF & Partners—Facilities & Capabilities
Idaho National Laboratory—Advanced Test Reactor, PIE facilities
Team Members/Collaborators
<p>Utah State University Heng Ban (principal investigator), Adam Zabriskie (graduate student)</p> <p>Idaho National Laboratory Donna P. Guillen (principal investigator)</p> <p>University of Nevada, Las Vegas Thomas Hartmann (collaborator)</p>

Advanced Damage-Tolerant Ceramics: Candidates for Nuclear Structural Applications

Introduction

Robust materials are critical to meeting the evolving designs of advanced, next-generation reactors and fuels. These materials must operate in extreme environments of elevated temperatures, corrosive media, and high-radiation fluences for lifetimes exceeding 60 years. Fully understanding a material's response to irradiation is paramount to ensuring long-term, reliable reactor service.

Meeting the designs of advanced reactors and fuels.

The research team is exploring a new class of machinable, layered, ternary carbides and nitrides known as the MAX phases as prime candidate materials for these demanding environments, either as fuel matrices or coating materials. They show excellent potential for significantly improving material performance thanks to their superior metallic characteristics for mechanical- and thermal-related designs, including:

- High-temperature capabilities (up to 1300°C)
- High damage tolerance
- Greater chemical resistance
- Ability to be manufactured in a variety of methods from slip casting to metal-injection molding.

While all MAX phases are fully machinable, some, such as Ti_3AlC_2 and Ti_3SiC_2 , show especially encouraging potential. They are similar to titanium metal in density but are three times as stiff. Their thermal and electrical conductivities are high and metal-like, and they have high fracture toughness. Some are chemically stable in corrosive environments, and ion studies prove they also possess a high tolerance to irradiation damage.

Project Description

This project investigates the damage inflicted on Ti_3AlC_2 , Ti_3SiC_2 , and chemical vapor deposited (CVD) SiC (for comparison) after exposure to a spectrum of neutron

irradiation consistent with conditions found in light water nuclear reactors (LWR).

The carbides are exposed to a series of neutron fluence levels at moderate to high irradiation temperatures (Table 1) in the ATR at the INL. The damage to the microstructures and the effects of the radiation on the mechanical and electrical properties of the materials is then characterized during post-irradiation examination (PIE). The results will provide an initial database that can be used to assess the microstructural responses and mechanical performances of these ternaries.

Accomplishments

A collaborative effort of INL, Savannah River National Laboratory, and Drexel University, this project was initiated in 2009. During its first year, all sample fabrication, capsule design, and initial characterization, including evaluation of microstructures and mechanical properties, were completed. Figures 1 and 2 show typical TEM micrographs of Ti_3AlC_2 and Ti_3SiC_2 . Figure 2 shows a Ti_3SiC_2 sample that was irradiated to $\sim 10^{-7}$ displacements per atom (dpa) with Californium (Cf) source neutrons. At such a low dose, irradiation damage was not expected, and none was observed.

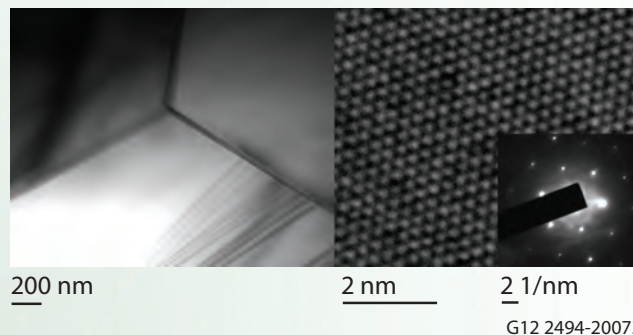

Figure 1. TEM micrographs of unirradiated Ti_3AlC_2 showing: a) a low-resolution, bright-field image of a triple point, b) a high-resolution image near the edge of the bottom grain in Figure 1(a). The inset shows a selected-area diffraction pattern from the same region with hexagonal symmetry of the basal planes.

Table 1. Test Matrix for Sample Irradiation.

	Temperature (°C)	Target Doses* (dpa)	Specimen Types
Ti_3SiC_2	100, 650, 1000	0.1, 1, 10	TEM, resistivity and tensile
Ti_3AlC_2			TEM, resistivity and tensile
SiC (CVD)			TEM, resistivity

* For simplicity use: $7 \times 10^{20} \text{ n/cm}^2 = 1 \text{ dpa}$ ($E > 1 \text{ MeV}$)

“With the irradiation complete, I am really looking forward to characterization of the MAX phases’ microstructures by transmission electron microscopy.”

Darin Tallman, Research Assistant, Drexel University

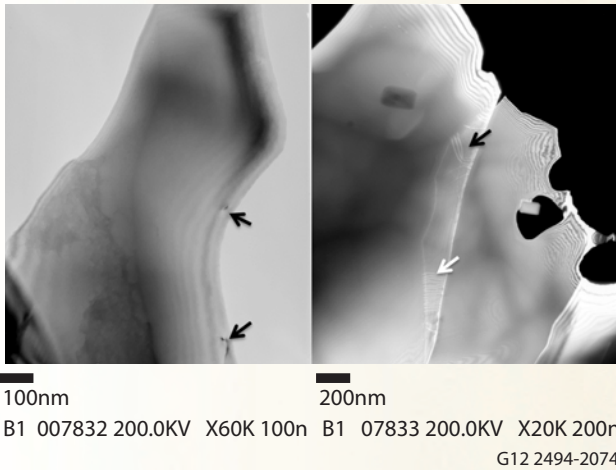

Figure 2. TEM micrographs of Ti_3SiC_2 irradiated with a Cf neutron source to a dose of $\sim 10^{-7}$ dpa. As expected, such a low dose resulted in no visible irradiation damage. Dislocations (black arrows) and stacking faults (white arrow) can be seen in both the a) bright-field and b) dark-field images of different regions.

In 2011, samples were successfully loaded into capsules at the INL and were inserted into the ATR for irradiation. The majority of 2011 was spent irradiating the materials. All irradiations have been completed. The last batch of samples was removed on November 26, 2011. Table 2 shows the irradiation status of each batch.

Future Activities

All samples are being stored in cooling pools. At the time of this writing, samples are scheduled to ship to PIE facilities in early spring of 2012. The research team expects samples to be stored until they are opened for cataloging and PIE in July 2012. Characterization of microstructure via transmission electron microscopy (TEM) will then be completed. Tensile samples of

each composition will be tested at room and irradiation temperatures. Resistivity measurements of irradiated materials will also be measured.

Publications and Presentations

1. E. N. Hoffman, M. W. Barsoum, R. L. Sindelar, D. Tallman. 2010. “MAX Phases and Their Potential for Nuclear Reactor Applications,” American Nuclear Society: 2010 Annual Meeting. San Diego, CA June 13-17, 2010
2. E. N. Hoffman, D. W. Vinson, R. L. Sindelar, D. J. Tallman, G. Kohse and M. W. Barsoum, “MAX Phase Carbides and Nitrides: Properties for Future Nuclear Power Plant In-Core Applications and Neutron Transmutation Analysis”. Submitted for publication to *Nuclear Engineering and Design*.
3. D. J. Tallman, E. N. Hoffman, D. Vinson, R. L. Sindelar, G. Kohse, M. W. Barsoum. 2011. “MAX Ceramics for Nuclear Applications: A New Material for a New Generation of Power.” The Metals, Minerals, and Materials Society 2011 Annual Meeting. San Diego, CA February 27-March 2, 2011.

Distributed Partnership at a Glance	
ATR NSUF & Partners—Facilities & Capabilities	
Idaho National Laboratory—Advanced Test Reactor, PIE facilities	
Team Members/Collaborators	
Drexel University Michel Barsoum (principal investigator), Darin Tallman (graduate student)	
Idaho National Laboratory Jian Gan (principal investigator)	
Savannah River National Laboratory Elizabeth Hoffman (collaborator)	

Table 2. Summary of Status of Samples Being Neutron Irradiated.

INL Capsule ID	Phases	Dose, dpa ($E > 1$ MeV)	Temperature ($^{\circ}C$)	Removal Date	Estimated Date of PIE Start
Drex- Rabbit	Ti_3SiC_2 , Ti_3AlC_2 & SiC	0.1	100, 650, 1000	Jul-2011	Jul-2012
Drex-B	Ti_3SiC_2 , Ti_3AlC_2 & SiC	1	100, 650, 1000	Jul-2011	Jul-2012
Drex-A	Ti_3SiC_2 , Ti_3AlC_2 & SiC	10	100, 650, 1000	Nov-2011	Jul-2012

Development and Validation of an Advanced Test Reactor Critical Radiation Transport Model

Principal Investigator: Denis Beller – University of Nevada, Las Vegas
(e-mail: bellerd@unlv.nevada.edu)

Introduction

The University of Nevada, Las Vegas (UNLV) and the ATR NSUF are collaborating on a three-year project that will demonstrate potential contributions of the ATR Critical (ATRC) facility to the National Nuclear Criticality Safety Program and to the International Criticality Safety Benchmark Evaluation Program (ICSBEP) by fielding criticality benchmark experiments.

Project Description

UNLV researchers are currently developing radiation transport models of the ATRC facility for conducting and evaluating integral and critical benchmark experiments. In 2010, UNLV researchers modified an existing ATR Monte Carlo N-Particle Transport Code (MCNP5) model of the ATR. They also used geometric modeling methods to convert drawings into components of surfaces, bodies and cells in order to modify the input file for the ATRC model. The researchers also examined known information to confirm that components and configurations in the model were consistent with the current physical condition of the ATRC. In September 2010, a draft ATRC benchmark evaluation was submitted to the ICSBEP for review.

Accomplishments

In Phase II of the project, researchers designed, fabricated and assembled a UNLV International Criticality Safety Benchmark Evaluation Project (ICSBEP) cassette which will be used to validate the ATRC model. The cassette will also be used to demonstrate the model's usefulness for future cross-cutting fuel cycle research and development, criticality benchmark evaluations, and other functions. Both the MCNP model and the validation experiments were developed in accordance with handbook guidelines from the International Reactor Physics Experiment Evaluation Project and the ICSBEP.

Preliminary modeling of a 1994 ATRC benchmark experiment was conducted during an ATR NSUF faculty-student research team project at the Center for Advanced Energy Studies (CAES) during the summer of 2010. A final report on that, and other work, was submitted to The Materials Society in San Diego, California in 2011, along with a summary of the project, for a presentation at its 2011 annual meeting.

The completed ICSBEP cassette was delivered to the INL for review by engineering staff and reactor operators, who provided suggestions on how to improve the conduct of the experiments. UNLV students then modified the components to prepare for the experiment, and submitted

Distributed Partnership at a Glance
ATR NSUF & Partners—Facilities & Capabilities
Idaho National Laboratory—Center for Advanced Energy Studies
Team Members/Collaborators
University of Nevada, Las Vegas Denis Beller (principal investigator), Alex Lui, Kimberly Clark (graduate students), Anthony Santo Domingo, Jacob Mills (undergraduate students)
Idaho National Laboratory John Bess, (principal investigator), J. Blair Briggs (collaborator), Daren Lords (experiment manager)

a draft experiment plan to INL. Subsequent modeling with MCNP was completed to provide detailed reactivity predictions for conducting the experiment (Figure 1). Detailed as-fabricated drawings of the components were also submitted for inclusion with the experiment plan (Figures 2 and 3).

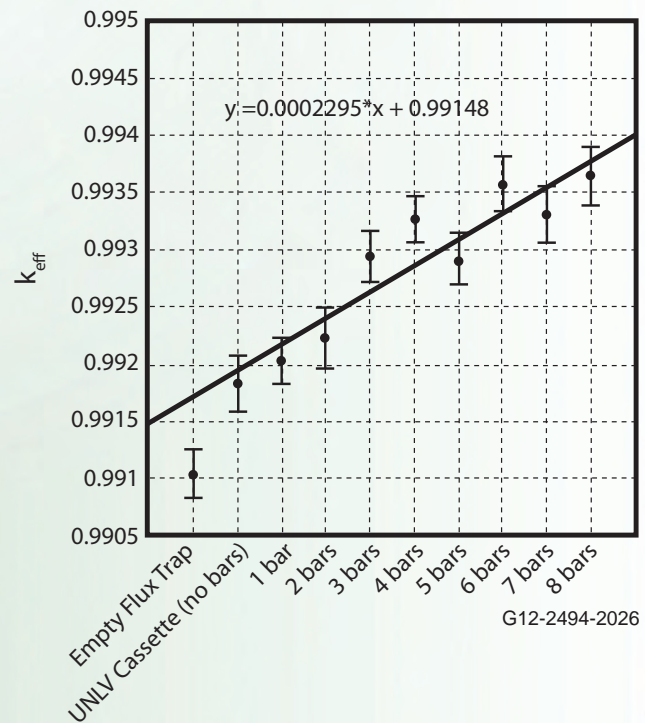

Figure 1. Effect of the Aluminum Bars in the UNLV ATRC Cassette on Reactor Criticality. The initial experiment will include all eight bars. They will then be removed one at a time, starting in the center. Thus, having seven bars does not mean one of the two outermost bars will be removed.

“Involvement in a real experiment in support of the nation’s nuclear science and technology programs is an invaluable experience for our students.”

Denis Beller, Research Professor, University of Nevada, Las Vegas

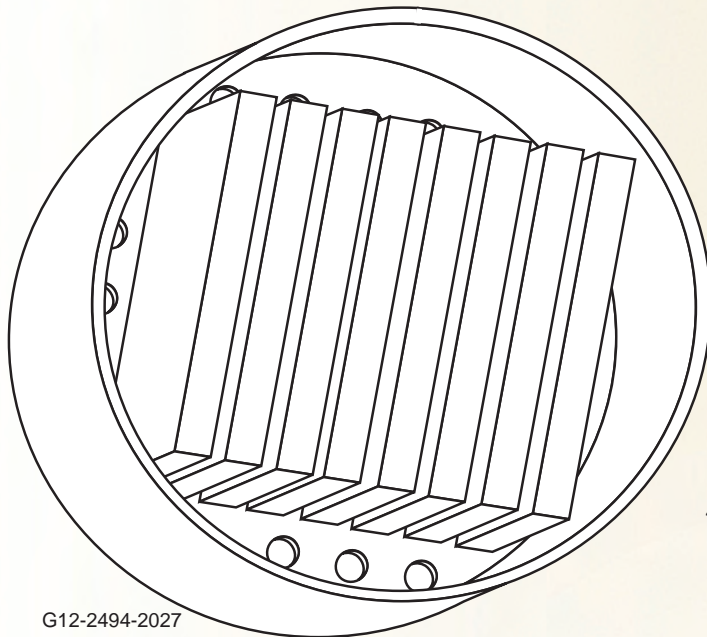

Figure 2. Artist's rendition of a cutaway of the UNLV ICSBEP cassette showing the water holes and the bars penetrating the spacer.

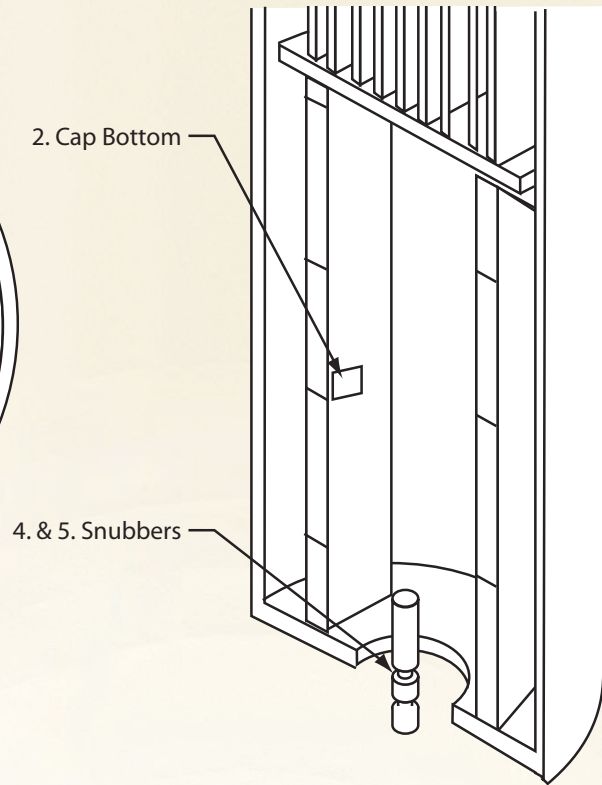

Figure 3. Artist's rendition of a cutaway of the bottom of the UNLV ICSBEP cassette showing the snubber (keeps the cassette centered in the ATRC flux trap) and the bottom support for the aluminum bars.

UNLV researchers modified an existing ATR Monte Carlo N-Particle Transport Code 5 (MCNP5) model of the ATR.

Future Activities

The modified UNLV ICSBEP cassette is scheduled to be delivered to INL in 2012. Researchers also plan to participate in the criticality benchmark experiment scheduled to be conducted that year. If the experiment is conducted early in 2012, it is anticipated that the benchmark evaluation will also be completed that year. If not, completion will have to be scheduled for 2013. Fabrication of other bars of highly absorptive material for the follow-on experiments is also scheduled for 2012.

Publications & Presentations

1. Denis Beller, “Final Report, Development and Validation of an ATRC Radiation Transport Model,” UNLV, Oct. 27, 2010.

2. Kimberly Clark (presenter), John Bess, and Denis Beller, “Criticality Benchmark of the Advanced Test Reactor Critical,” poster, 2010 American Nuclear Society Winter Meeting and Nuclear Technology Expo, Nov. 8, 2010, Las Vegas, NV.
3. Kimberly Clark (presenter), John Bess, and Denis Beller, “Criticality Validation and Reactor Physics Experiment for ATR NSUF,” oral presentation, 2011 Annual Meeting of The Materials Society, San Diego, CA, Feb 27 – Mar 3, 2011.
4. Kimberly Clark (presenter), John Bess, and Denis Beller, “Criticality Benchmark of the Advanced Test Reactor Critical,” poster, 2011 ATR NSUF Users Week, Idaho National Laboratory, Idaho, June 2011. This poster/presentation resulted in a 2nd place award.

Developing a Mechanistic Understanding of Radiation Tolerant Materials

Principal Investigator: David T. Hoelzer – Oak Ridge National Laboratory
(e-mail: hoelzerd@ornl.gov)

Introduction

Ferritic alloys play an important role in guiding the development of advanced radiation tolerant materials that will be required for future nuclear reactor concepts. Developing radiation tolerant alloys will provide significant benefits to the Department of Energy by improving the performance and safety of components for advanced nuclear energy systems.

This project was initiated in 2010 to conduct ion irradiation and helium (He) implantation experiments on the advanced oxide dispersion strengthened (ODS) 14YWT ferritic alloy (Fe-14Cr-3W-0.4Ti-0.3Y₂O₃ - wt. %) that was developed at Oak Ridge National Laboratory (ORNL). The irradiation experiments were conducted using ATR NSUF partner facilities at the Michigan Ion Beam Laboratory (MIBL). However, this project has grown into a collaboration between ORNL and the University of Michigan (UM).

Project Description

The objective of the project is to study the tolerance of the advanced ODS 14YWT ferritic alloy to high dose radiation damage, including the accumulation of helium (He). This particular alloy contains a novel microstructure that consists of a high concentration of nano-size titanium (Ti), yttrium (Y) and oxygen (O) enriched clusters, or nanoclusters (NC), as well as ultra-fine size grains. The goal in producing these microstructures is to achieve high sink strength for the attraction of point defects and He during irradiation. The resulting recombination of these defects with transmutation products such as He, forms nano-size bubbles and cavities that prevent the He from accumulating on grain boundaries as large bubbles, which cause alloy embrittlement.

The team at ORNL provided samples of 14YWT (SM11 heat) for high dose Fe ion irradiation and He ion implantation experiments. These experiments will be followed by transmission electron microscopy (TEM) characterization of the irradiated specimens. The team at the UM conducted the ion irradiation experiments at the MIBL and will provide local electrode atom probe (LEAP) characterization of the irradiated specimens.

Accomplishments

A total of 18 specimens of 14YWT were prepared with dimensions of 20 mm x 2 mm x 3 mm, and one surface of each specimen was polished with colloidal silica. Beginning in December 2010 and finishing in late

The goal for achieving radiation tolerant materials is to achieve high sink strength for the attraction of point defects and He during irradiation.

March 2011, the irradiation experiments were each conducted using two specimens. One set of experiments irradiated the specimens with 5 MV Fe²⁺ ions to 10, 100 and 200 dpa at 200°C using the 1.7 MV Tandem Accelerator. The second set of experiments, illustrated in the Stopping and Range of Ions in Matter (SRIM) plot (Figure 1), irradiated the specimens by implanting 400 atomic parts per millions (appm) He at 25°C into the polished surface using the 400 k V ion implanter. This was followed by irradiating the specimens with 5 MV Fe²⁺ ions to 10 displacements per atom (dpa) at 200° C and 500° C using the 1.7 MV tandem accelerator. One specimen from each experiment was sent to ORNL for TEM analysis, while the other remained at the UM for LEAP analysis.

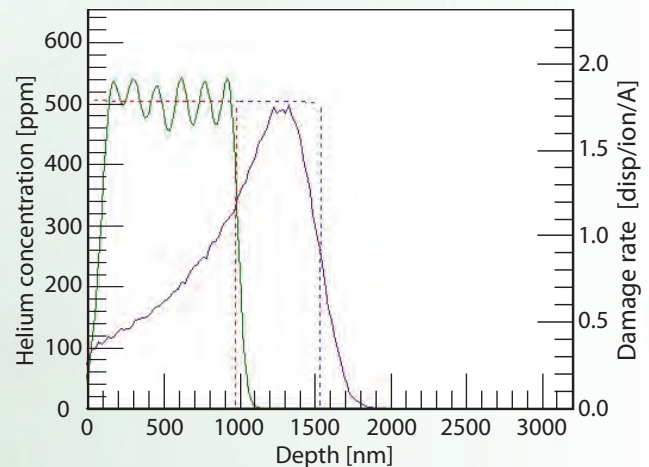

Left Y-axis Helium implants
— Total
Right Y-axis — Damage produced by 5 MeV Fe⁴⁴ ions

420 keV-9.5x10¹⁴ He⁴⁴/cm²
310 keV-6.6x10¹⁴ He⁴⁴/cm²
220 keV-6.6x10¹⁴ He⁴/cm²
140 keV-6.8x10¹⁴ He⁴/cm²
80 keV-6.0x10¹⁴ He⁴/cm²
40 keV-5.0x10¹⁴ He⁴/cm²

G12 2494-2075

Figure 1. SRIM plot showing the He concentration resulting from a series of He implantations into the surface of the 14YWT specimen and the subsequent damage profile produced from Fe²⁺ ion irradiation.

The ion irradiation experiments initiated at MIBL in this project were a key factor to the emergence of the collaboration between ORNL and UM on development of radiation tolerant materials.

David Hoelzer, Researcher, Oak Ridge National Laboratory

Future Activities

Subsequent microstructural studies, which are not part of the scope of this ATR NSUF project, are planned for 2012 and will focus on investigating the stability of the NC at 200° C using the Fe²⁺ ion irradiations. At that relatively low temperature, it is expected that the roles of the point defect formation and the diffusion through the body centered cubic (bcc) Fe lattice will vary. Researchers also plan to use the combined He implantation and Fe²⁺ ion irradiations to study the trapping behavior of He by the NC and grain boundaries.

Specimens for TEM analysis are scheduled to be prepared at ORNL using the lift-out focused ion beam (FIB) technique in conjunction with stopping and range of ions in matter (SRIM) plots. The results obtained from these experiments promise to guide further developments in advanced alloys, which will help achieve the radiation tolerance required for future nuclear reactor concepts. Similar specimen preparation for LEAP analysis is scheduled at the UM.

Distributed Partnership at a Glance
ATR NSUF & Partners—Facilities & Capabilities
University of Michigan —Ion Beam Laboratory
Team Members/Collaborators
Oak Ridge National Laboratory David Hoelzer (principal investigator), P. Duo (graduate student)
University of Michigan Gary Was, Emmanuelle Marquis (collaborators)

Real-Time Advanced Test Reactor Critical Facility (ATRC) Flux Sensors

Introduction

Although unsurpassed with respect to irradiation testing capabilities, the ATR currently lacks real-time methods for directly detecting thermal neutron flux and fission reaction rates for irradiation capsules. The ATR Modeling, Simulation and V&V Upgrade Initiative recognizes the need to improve ATR software, tools, computational protocols and in-core instrumentation. Likewise, the ATR Life Extension Project supports work to improve replacement nuclear instrumentation.

The uncertainty associated with current real-time flux detector data may be as high as 30 percent.

The use of real-time flux detectors in the ATR is essential to its efforts to support Department of Energy programs to evaluate the suitability of new fuels and materials proposed for existing and advanced nuclear power plants, and the ability of materials in the current commercial fleet to withstand proposed life extensions.

Project Description

Gaining insights into which type of detector can provide the best online regional ATR Critical (ATRC) power measurement offers the potential to increase the ATRC's ability to perform low-level irradiation experiments using specialized fixturing along with software currently being developed for this project. In addition, the data gained should provide insights about the viability of using these detectors in ATR.

The specific objectives of this joint project are to compare the accuracy, response times and long-duration

a) SPNDs

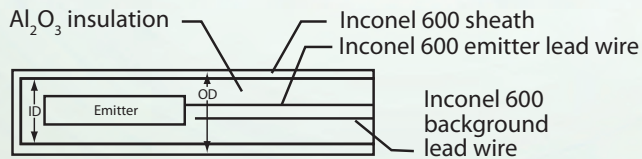

b) CEA fission chambers

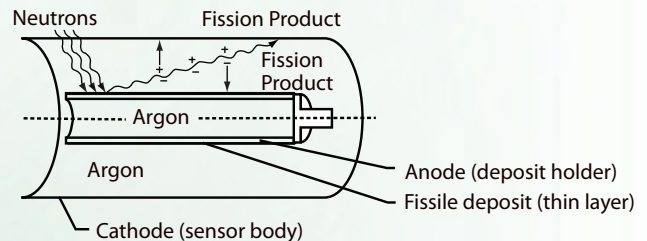

c) BTB fission chambers

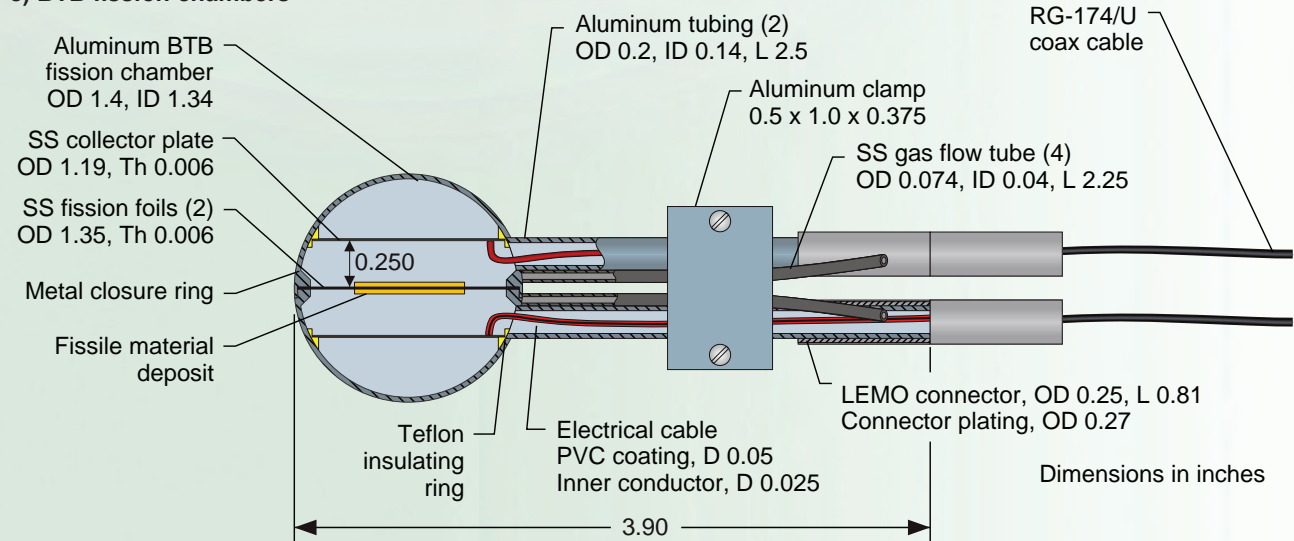

Figure 1. Real-time flux detectors for evaluation: a) SPNDs, b) CEA fission Chambers, c) BTB fission chambers.

“Working on the ATRC flux sensor project has provided me with an invaluable educational and research experience that I know will help in my development as an engineer after graduation.”

Eric Bonebrake, College of Science and Engineering, Idaho State University

performances of several real-time sensors (Figure 1), including:

- Miniature fission chambers developed by the French Atomic Energy Commission (CEA)
- Specialized, self-powered neutron detectors (SPNDs) developed by the Argentinean National Energy Commission (CNEA)
- Specially developed commercial SPNDs
- Back-to-back (BTB) fission chambers developed by Argonne National Laboratory (ANL).

The team effort continues with the development of specialized sensor positioning hardware and associated software at the INL to facilitate the evaluations. Calculations made by Idaho State University (ISU) assess the performance of the new flux detection sensors and compare data with existing flux wire measurements employed in ATRC fuel elements. The uncertainty

associated with current real-time flux detector data may be as high as 30 percent. Therefore, the need to properly calibrate these detectors is crucial for obtaining valid results. These tasks offer significant promise toward lowering that figure, increasing INL’s ability to obtain more precise flux measurements.

Accomplishments

In October 2010, foils were irradiated in the Northwest Large In-Pile Tube (NW-LIPT) and flux detector testing was initiated in the ATRC using the specialized fixturing shown in Figure 2. The Experimental Guide Tubes (EGTs) used to evaluate real-time flux detectors (e.g., fission chambers and SPNDs) are primarily fabricated from aluminum to minimize their weight. However, selected components, such as the guide tubes, are made from stainless steel 304 to make them more robust.

The six EGTs mechanically positioned detectors at a specified vertical location in four N-16 exterior positions

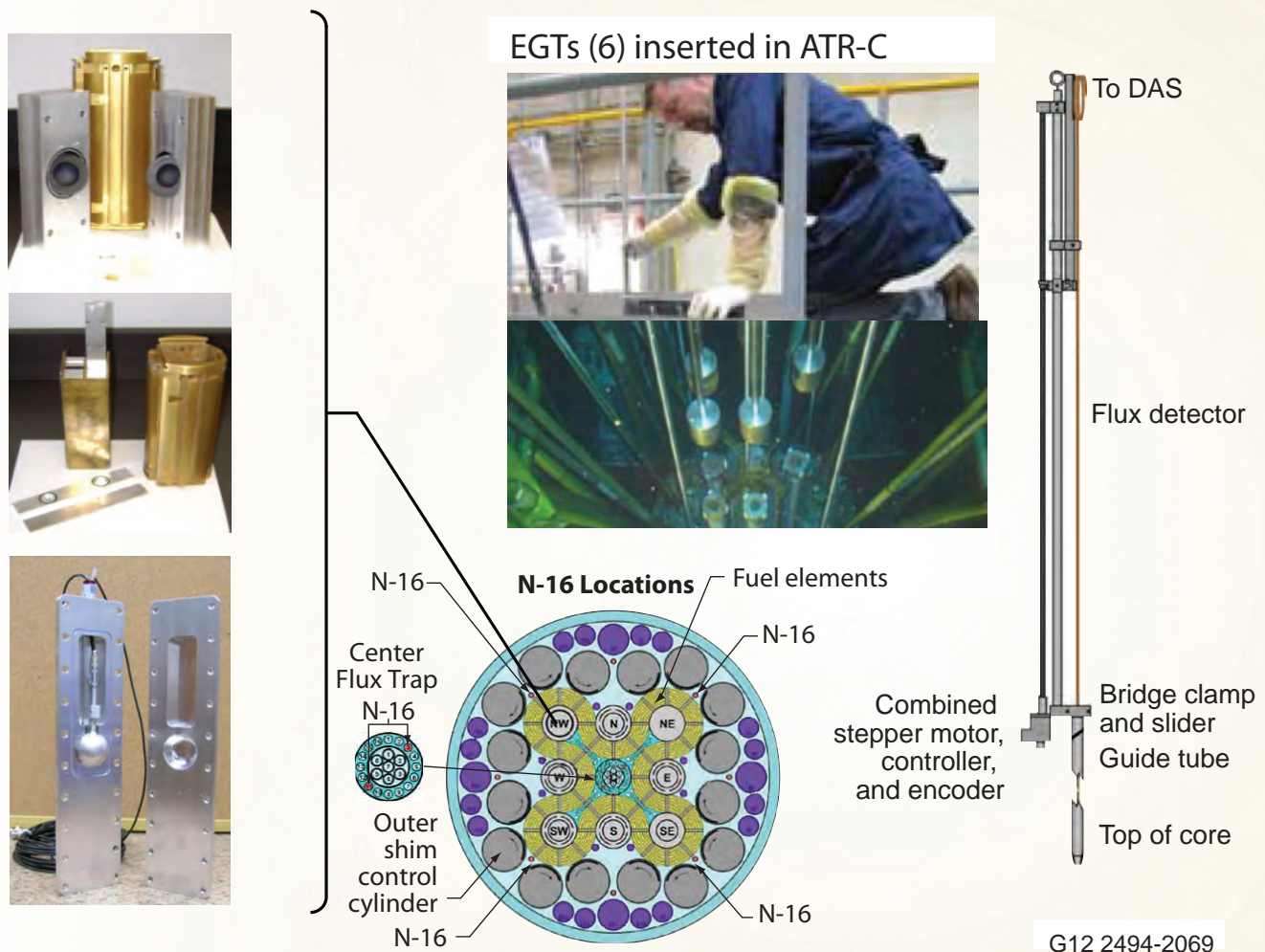

Figure 2. Specialized fixturing for flux detector evaluation in the NW-LIPT (left), and EGTs for evaluations in six N-16 positions (right).

Real-Time Advanced Test Reactor Critical Facility (ATRC) Flux Sensors (cont.)

and two Center Flux Trap N-16 positions. A total of four irradiations were performed. Foils and wires were irradiated to provide validation measurement data for code developers. National and international partners were present to assist with the initial evaluations.



Figure 3. Fixture for positioning BTB and CEA miniature fission chambers in ATRC NW-LIPT.

ATRC operational difficulties prevented additional testing in 2011, so efforts focused on developing the fixture design and finalizing test plans for installing the BTB fission chambers in the NW-LIPT. Fabrication continued to progress on specialized fixturing that will allow a BTB chamber to be inserted into the ATRC alongside other real-time flux detectors, such as SPNDs or the CEA fission chambers, which will allow responses to be compared in nearly identical flux conditions. The water-tight test fixture that will be used to insert these BTB chambers is shown in Figure 3, along with an insert being fabricated that will position three fission chambers for assessment of the flux gradient across the LIPT.

Also completed in 2011, was fabrication of two new foil holders for the Southeast Standard In-Pile Tube (SE-SIPT) which support the ATR Modeling, Simulation and V&V Upgrade initiative. In addition, newly constructed BTB fission chambers were used at ISU for cross calibration between calibrated and uncalibrated uranium foils originally developed by Argonne National Laboratory. The calibrations were performed, beginning in March 2011, by irradiating the BTB fission chambers in three different neutron environments at ISU's Idaho Accelerator Center using the AGN-201 nuclear reactor, 25 Me V linac, and a 50 Ci AmBe sealed neutron source. The experiments, which concluded at the end of November 2011, involved using a variety of combinations of the calibrated and uncalibrated foils in the BTB fission chambers.

Future Activities

The following tasks are anticipated to be performed in 2012:

- Continued evaluations of SPNDs and CEA fission chambers using specialized fixturing developed to axially position the detectors in the N-16 positions of ATRC
- Fabrication of fixturing for installing BTB fission chambers in the NW-LIPT which will be deployed in flux detector evaluations at ATRC
- Complete calibration of newly constructed BTB chambers now in ongoing testing at ISU
- Validation measurement testing for the ATR Modeling, Simulation and V&V Upgrade initiative.

Distributed Partnership at a Glance
ATR NSUF & Partners—Facilities & Capabilities
Idaho National Laboratory —Advanced Test Reactor Critical Facility
Team Members/Collaborators
Idaho State University Dr. George Imel, Dr. Jason Harris (principal investigators), Eric Bonebrake (M.S. candidate)
Idaho National Laboratory Joy Rempe (principal investigator), Troy Unruh (Ph.D. candidate), Dave Nigg, Ben Chase (collaborators)
Commissariat à l’Energie Atomique (CEA) Jen Francois Villard, Benoit Geslot, Christophe Moergue (collaborators)

Publications

1. Troy Unruh, Joy Rempe, David Nigg, Paul Hart, George Imel, Jason Harris, and Eric Bonebrake, "Flux Sensor Evaluations at the ATR Critical Facility," 7th International Topical Meeting on Nuclear Plant Instrumentation, Control, and Human Machine Interface Technologies (NPIC&HMIT 2010), Las Vegas, NV, November 7-11, 2010.
2. J. Rempe, D. Knudson, J. Daw, T. Unruh, B. Chase, K. Condie, J. Palmer, and K. Davis, "Enhanced In-pile Instrumentation at the Advanced Test Reactor," *Proceedings of the Second International Conference on Advancements in Nuclear Instrumentation, Measurement Methods and their Applications (ANIMMA2011)*, Ghent, Belgium, June 2011.

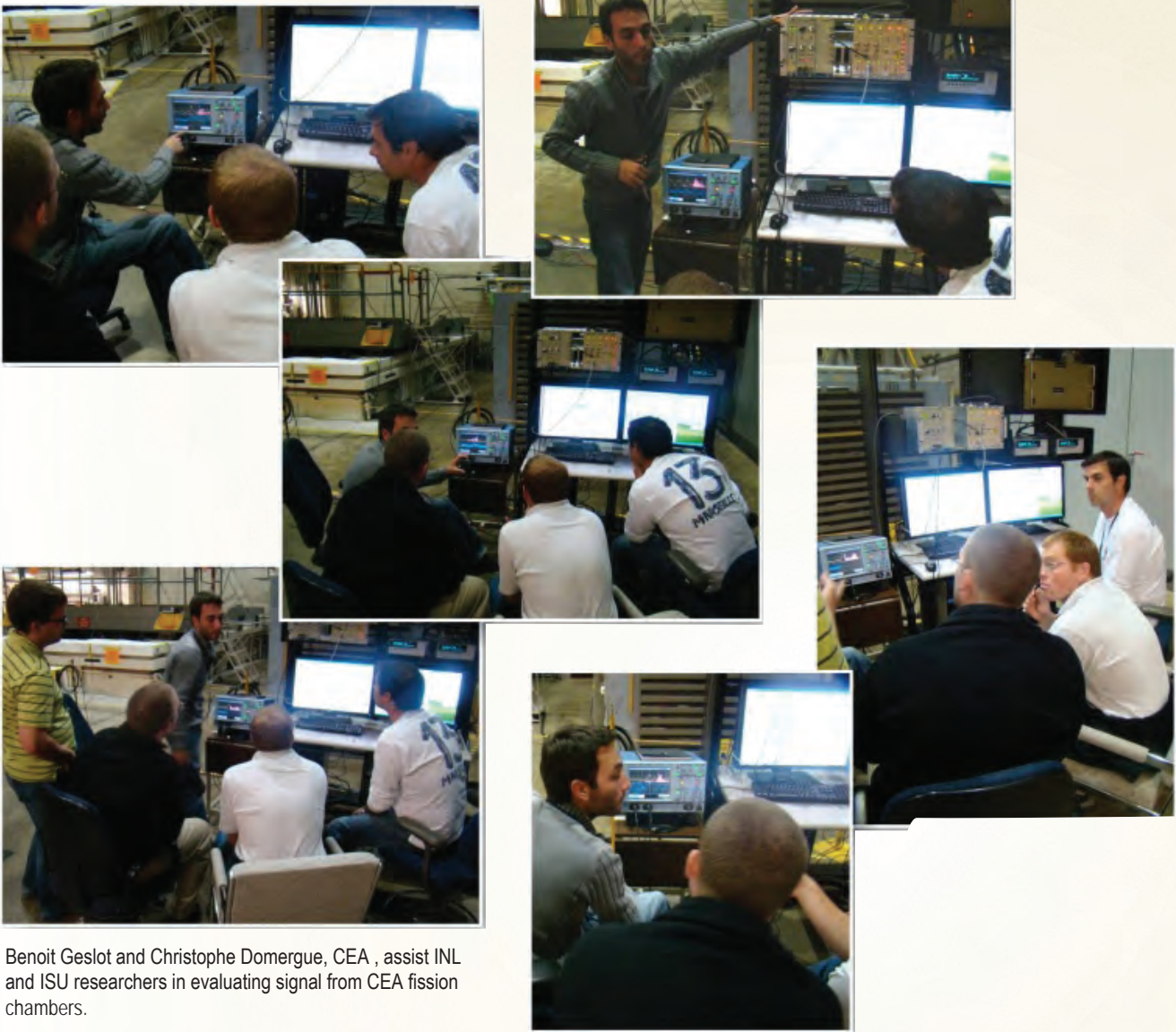

Benoit Geslot and Christophe Domergue, CEA, assist INL and ISU researchers in evaluating signal from CEA fission chambers.

Measurement of Actinide Neutronic Transmutation Rates with Accelerator Mass Spectroscopy (MANTRA)

Introduction

If future fuel cycle studies for Generation IV reactor systems are to be innovative and productive, they will require more accurate data than are currently available. The very high mass actinides can play a significant role in the feasibility assessment of these fuel cycles. Irradiating very pure actinide samples in the ATR and determining the amounts of different transmutation products present will generate data on minor actinide reaction rates that are presently lacking. The determination of the nuclide densities before and after neutron irradiation will allow inference of energy-integrated neutron cross sections.

For example, the potential build-up of ^{252}Cf when recycling transuranic (TRU) waste in a light water reactor (LWR) leads to increased neutron emissions that could impact the fuel fabrication process. As a consequence, nuclear data of higher mass transuranics should be significantly improved.

These were the first runs using actinides at the ATLAS facility since 2000.

Project Description

MANTRA was started as an ATR NSUF project in January 2010. The MANTRA approach is unique in that some of the atom densities of the transmutation products produced by irradiation are determined using accelerator mass spectrometry (AMS) in the ATLAS Analysis Support Center located at the Argonne National Laboratory (ANL). Using very small amounts of material, this highly sensitive technique is capable of measuring quantities of long-lived, rare isotopes with high discrimination in the presence of more abundant ones. AMS facilities have traditionally been limited to the assay of low-to-medium atomic mass materials: $A < 100$. However, there has recently been progress in extending AMS to heavier isotopes, even to $A > 200$. AMS can detect abundances as low as 10^{-12} , orders of magnitude lower than that of standard mass spectrometry techniques. This allows for more transmutational products to be measured and, consequently, more neutron cross-sections to be inferred from a single sample. In order to acquire independent sets of measurements, more conventional analytical and radiochemical techniques were also used, including:

- Inductively-coupled plasma quadrupole mass spectrometry (ICP-QMS)
- Thermal ionization mass spectrometry (TIMS).

Accomplishments

In November 2010 several actinide test samples (U, Th and Cm) were prepared at the INL and sent to the ANL for testing (Figure 1). The laser ablation was not yet operational and could not be tested. However, these were the first runs using actinides at the ATLAS facility since 2000. The objectives of these tests were to determine:

- The ion source performance with the quartz liner
- The level of backgrounds with the quartz liner
- The detector performances

The nature of the test samples had been agreed upon during a MANTRA meeting at INL in September 2010. The approach first suggested to try and generate the oxide targets was to precipitate the hydroxide of the required elements. It was anticipated that this would be followed by the formation of the oxide via calcinations. However, due to difficulties in the filtration of precipitates, the unnecessary waste of reagents, and the uncertainty of producing compositions in the 2-3 mg range, this approach was discarded. A decision was made to try the more direct approach of calcining nitrates of the desired elements into their corresponding oxides. This method provided the means for producing quantitative oxides of these elements at the 2-3 mg level required for fabrication all in one step. The results of the initial test run, which studied backgrounds, detector response and accelerator scaling repeatability, are referenced in Publication 5.

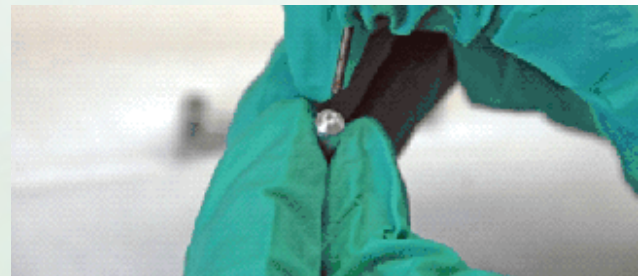

Figure 1. Loading an actinide sample in the AMS ion source sample holder

The maximum allowable initial levels of impurity of isotope $A+1$ in a fission product sample of mass number A , allowing inference of σ_{Ac} with an uncertainty of no more than $\pm 5\%$ when the atom densities are measured with an uncertainty of $\delta = \pm 1\%$ or $\delta = \pm 0.5\%$, have also been determined by calculating the differences for different fission products of interest for reactor applications. These numbers have been calculated considering an irradiation of 1 ATR cycle with a cadmium filter ($\Phi \sim 2 \times 10^{14} \text{ n.cm}^{-2}.\text{s}^{-1}$) and 2 ATR cycles with a thin boron filter or a thick boron filter ($\Phi \sim 10^{14} \text{ n.cm}^{-2}.\text{s}^{-1}$).

“We continue to be very excited to be able to participate in a scientific experiment that brings the ATR NSUF into collaboration with two premier national laboratories.”

George Imel, Professor of Nuclear Engineering, Idaho State University

The final flux monitors necessary to characterize the neutron spectra in the samples were titanium, cobalt in aluminum, nickel, iron, copper, and uranium (enriched in 235). Since the neutron cross-sections of the isotopes are well-known, the measurement of their activities after irradiation allows for unfolding the neutron spectrum in which it was irradiated.

The enriched boron filters necessary to tailor the neutron spectrum to the ATR and simulate a fast neutron reactor were fabricated by Ceradyne and shipped to INL in July 2011. These filters will be wrapped around the samples to shield them from the high thermal neutron flux and provide a fast flux environment (Figure 2).

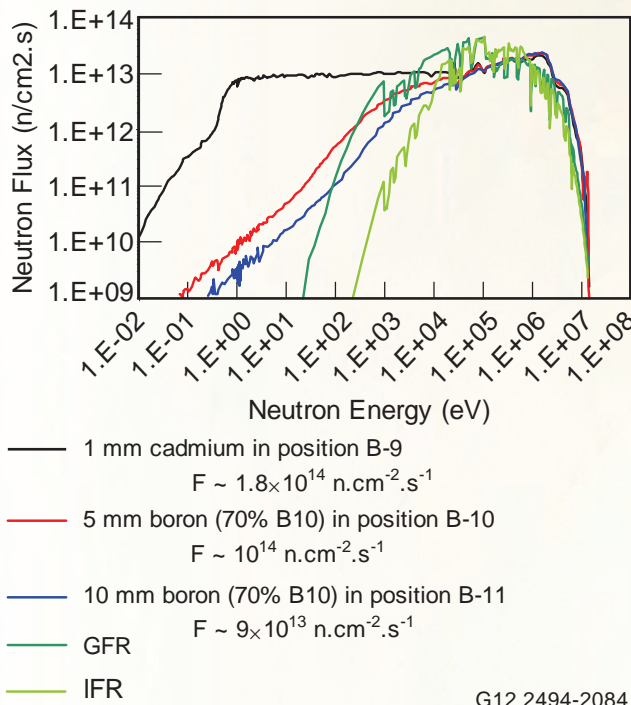

Figure 2. Boron-filtered and cadmium-filtered neutron spectra in large B positions vs. neutron spectra in advanced fast neutron reactors (gas-cooled fast reactors and lead-cooled fast reactors).

Future Activities

The first irradiations are scheduled to begin in 2012, assuming delays at INL’s Materials and Fuels Complex (MFC) can be resolved.

Publications & Presentations

1. G. Youinou, G. Palmiotti, M. Salvatores, G. Imel, R. Pardo, F. Kondev, M. Paul, “Principle and Uncertainty Quantification of an Experiment Designed to Infer Actinide Neutron Capture Cross-Sections”, INL/EXT-10-17622 (2010).
2. G. Youinou, M. Salvatores, M. Paul, R. Pardo, G. Palmiotti, C. McGrath, F. Kondev, G. Imel, “MANTRA: An Integral Reactor Physics Experiment to Infer Actinide Capture Cross-Sections From Thorium To Californium With Accelerator Mass Spectrometry”, Eleventh International Conference on Nuclear Data for Science and Technology, Jeju Island, Korea, 2010, published in the Journal of the Korean Physical Society, Vol. 59, No. 2, August 2011, pp. 1940-1944.
3. G. Youinou was invited to the FCR&D Nuclear Physics Working Group meeting (June 24-25, 2010, Port Jefferson, NY) to present the MANTRA experiment.
4. of the Expert Group on Integral Experiments for Minor Actinide Management (September, 13-14, 2010, NEA Headquarters, Issy-les-Moulineaux, France) to present the MANTRA experiment.
5. R.C. Pardo, F.G. Kondev, S. Kondrashev, C. Nair, T. Palchan, R. Scott, D. Seweryniak, R. Vondrasek, M. Paul, P. Collon, C. Deibel, G. Youinou, M. Salvatores, G. Palmotti, J. Berg, J. Fannesbeck, G. Imel, “Toward Laser Ablation Accelerator Mass Spectrometry of Actinides with an ECRIS and Linear Acceleration and Initial Background Studies” Submitted to Nuclear Instruments and Methods (B).

The principle and status of the MANTRA experiment was presented to an international panel during the Nuclear Science & Technology Directorate Review in June 2011.

Distributed Partnership at a Glance
ATR NSUF & Partners—Facilities & Capabilities
Idaho National Laboratory—Advanced Test Reactor
Team Members/Collaborators
Idaho State University Dr. George Imel (principal investigator), Eric Burgett (collaborator), Jyothir Kumar (graduate student)
Idaho National Laboratory Gilles Youinou (co-principal investigator)

In August 2011 the MANTRA integral reactor physics experiment was presented to the Department of Energy (DOE) during a two day meeting between the principal investigators (with 2009 and 2010 awards in Applications of Nuclear Science and Technology supported by the DOE Office of Nuclear Physics and American Recovery and Reinvestment Act ARRA funds), and NP federal program managers. The slides are available at <http://science.energy.gov/np/benefits-of-np/anst/anst-exchange-meeting-08222011>.

Irradiation and Examination Program for Triplex SiC Composite Tubing for PWR Fuel Cladding Applications

Introduction

The reactor failure caused by the tsunami that devastated four of the six reactors in the Fukushima, Japan, nuclear power plant makes it even clearer that fuel behavior must be improved in loss-of-coolant accidents (LOCA) at nuclear reactors. Triplex SiC composite cladding could be a significant contributor to finding a solution.

However, the existing database for the behavior of triplex type SiC/SiC composite clad tubing in light water reactor (LWR) environments is very limited. Therefore, one of the major technical goals of this research is to collect as much relevant information as possible for using triplex tubing as reactor fuel clad. Obtaining this data in a relatively short time will assist tubing manufacturers in improving the irradiation behavior of the material. It is also important in building sufficient confidence in the material behavior to justify expensive, time-consuming integral fuel tests in test reactors.

Project Description

This project is part of a larger effort to develop and qualify SiC composite materials for use as pressurized water reactor (PWR) fuel cladding. The primary focus of the research is to expose a variety of candidate tubing materials and bonding methodology samples to PWR conditions in an in-core loop at the Massachusetts Institute of Technology research reactor (MITR). Post-irradiation examinations (PIE) are used to characterize the corrosion behavior and mechanical property evolution of the samples.

The MITR PWR loop tests play a key role in the research, because they allow researchers to study the interaction between the cladding and the coolant under prototypical reactor conditions.

Other related research, such as that conducted in the High Flux Isotope Reactor (HFIR) reactor at the Oak Ridge National Laboratory (ORNL), addresses such areas as fuel/cladding interaction and coolant/clad interactions under potential LOCA or other off-normal conditions. Over the course of the project, the MITR team has used the loop tests to accumulate the equivalent of approximately three years of reactor exposure for the most-exposed materials still in the test.

The potential benefits of successfully developing the SiC/SiC-composite “Triplex Ceramic Cladding” as a replacement for zirconium alloy fuel cladding include far fewer chemical reactions in the cladding at normal

Triplex SiC composite cladding has great potential for improving fuel behavior during loss of coolant accidents.

operating conditions and during LOCAs and departure from nucleate boiling (DNB) transients, and increased fuel burn-up.

These benefits are derived from SiC’s inherent high-temperature strength and radiation resistance as well as the man-made features that have been engineered into it (Figure 1):

- An inner monolithic SiC layer that seals the clad and prevents the release of fission product gases
- An SiC, fiber-based composite middle layer that provides mechanical strength and a “graceful” failure mode that confines the solid fission products and maintains a coolable geometry even under LOCA conditions
- An outer layer of chemical vapor deposited (CVD) SiC forms and an environmental barrier coating (EBC).

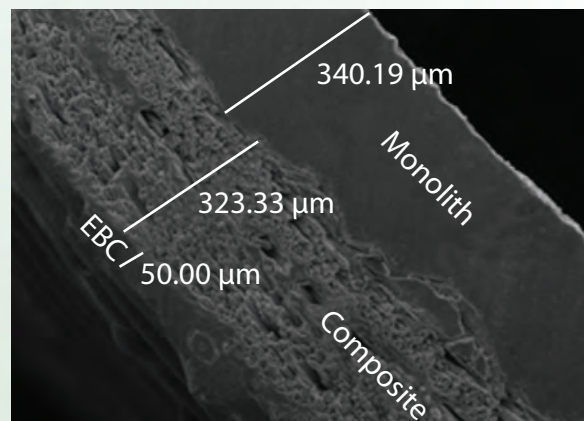

Figure 1. SEM micrograph cross section showing the three layers of the triplex cladding design.

“If proven feasible, the SiC clad will double the amount of energy extracted from the fuel, greatly reducing the spent fuel burden from LWRs.”

Mujid S. Kazimi, TEPCO Professor of Nuclear Engineering and Director of MIT Center for Advanced Nuclear Energy Systems

Accomplishments

During this past project year, two modules of tube samples—designated “Round 6” and “Round 7,” respectively—accumulated about 185 full-power days of reactor exposure. Round 6 consisted of samples from an earlier production run in which the research team incorporated lessons learned from earlier rounds of irradiation testing and PIE, while the samples in Round 7 were identical to the tubes being used in the HFIR tests.

In addition, during the first 100 days of the exposure, two samples of bonding material were also exposed. Researchers at both of the major project partners are working with a variety of manufacturers and labs to develop a bonding method to secure an end plug in the triplex clad tube after the fuel pellets have been loaded.

Because developing an effective bonding material is critical to finding any practical solution for triplex fuel clad, the evaluation of bond methodologies under reactor conditions is an important aspect of this project. Its significance was underscored when results of an initial bond test carried out in 2010 indicated that several bonding methods that survived in unirradiated autoclave tests failed in reactor testing. Although the failure mechanisms have not yet been determined, it is clear that in-reactor testing is required to fully qualify any potential bond system.

Both bonding methods irradiated during this project year were the same type as was developed at the Pacific Northwest National Laboratory (PNNL). The first method was the only bond that survived the earlier round of irradiated testing, and the second was a fresh, unirradiated sample of the same type. Both of these samples debonded during the 100-day test. (Note: This may be an overly conservative irradiation test since the samples were exposed in-core, whereas the upper-end plug in an actual fuel element is well above the fuel level and is exposed to much less neutron flux.)

Interim PIE examinations were not performed on the in-test samples during this reporting period, but an ambitious range of destructive PIE was carried out by the MIT Nuclear Science and Engineering Department. Burst testing on all available irradiated and unirradiated triplex tubing was also performed, and the results were compared to earlier testing that had been performed by researchers at Ceramic Tubular Products, LLC.

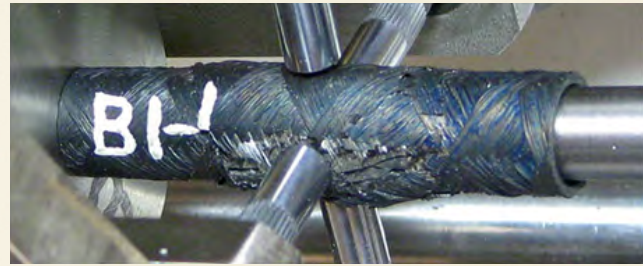

G12-2494-2018

Figure 2. (top) Round 6 triplex tube undergoing mandrel-driven expanding plug burst testing.



G12-2494-2019

Figure 3. (left two) Round 7 triplex tube before and after expanding plug burst test to failure. (right two) A “monolith-only” tube before and after expanding plug burst test to failure.

Figures 2 and 3 show a triplex tube undergoing burst testing and illustrate the “graceful failure” effect produced when the composite layer is added to the triplex tubes. With the composite layer, the tube maintains coherence during through-wall cracking. Without this layer, the tube shatters.

The MIT researchers also demonstrated that Xenon flash thermal diffusivity measurements can be carried out on segments cut from the triplex tubes. They compared the thermal diffusivities and conductivities of a variety of exposed and unexposed materials and concluded that degradation of the triplex tubing under irradiation is similar to that observed in monolithic SiC, with saturation of the decrease occurring at about 1 displacement per atom (dpa). It is likely that corrosion films also play a role in the observed differences between the exposed and unexposed samples.

Future Activities

In 2012, a new set of bond samples, including some involving methods not previously tested, will be added

Irradiation and Examination Program for Triplex SiC Composite Tubing for PWR Fuel Cladding Applications (cont.)

to the Round 6 and Round 7 tube modules. Irradiation will continue until late in the fiscal year and will be followed by the removal of all modules and the non-destructive examination of all samples. In consultation with our collaborators, the MIT team will identify samples to be held over for possible further exposure under new funding. All other samples will be allocated for burst and thermal diffusivity testing.

Publications

1. Ken Yueh, David Carpenter and Herbert Feinroth, "Clad in Clay," Nuclear Engineering International, March 8, 2010.
2. David Michael Carpenter, Ph.D. Thesis, Supervised by Prof. Mujid Kazimi, "An Assessment of Silicon Carbide as a Cladding Material for Light Water Reactors," MIT Nuclear Science and Engineering, October 2010.
3. J. D. Stempien, D. Carpenter, G. Kohse, and M. S. Kazimi, "Behavior of Triplex Silicon Carbide Fuel Cladding Designs Tested Under Simulated PWR Conditions," MIT-ANP-TR-134, Center for Advanced Nuclear Energy Systems, MIT, 2011.

Distributed Partnership at a Glance

ATR NSUF & Partners—Facilities & Capabilities

Massachusetts Institute of Technology—Reactor

Team Members/Collaborators

Massachusetts Institute of Technology

Mujid Kazimi (principal investigator), Edward Pilat (collaborator), David Carpenter (student)

Idaho National Laboratory

Mitch Meyer (principal investigator)

Westinghouse Electric Company

Edward Lahoda (collaborator)

Ceramic Tubular Products

Herbert Feinroth (collaborator)

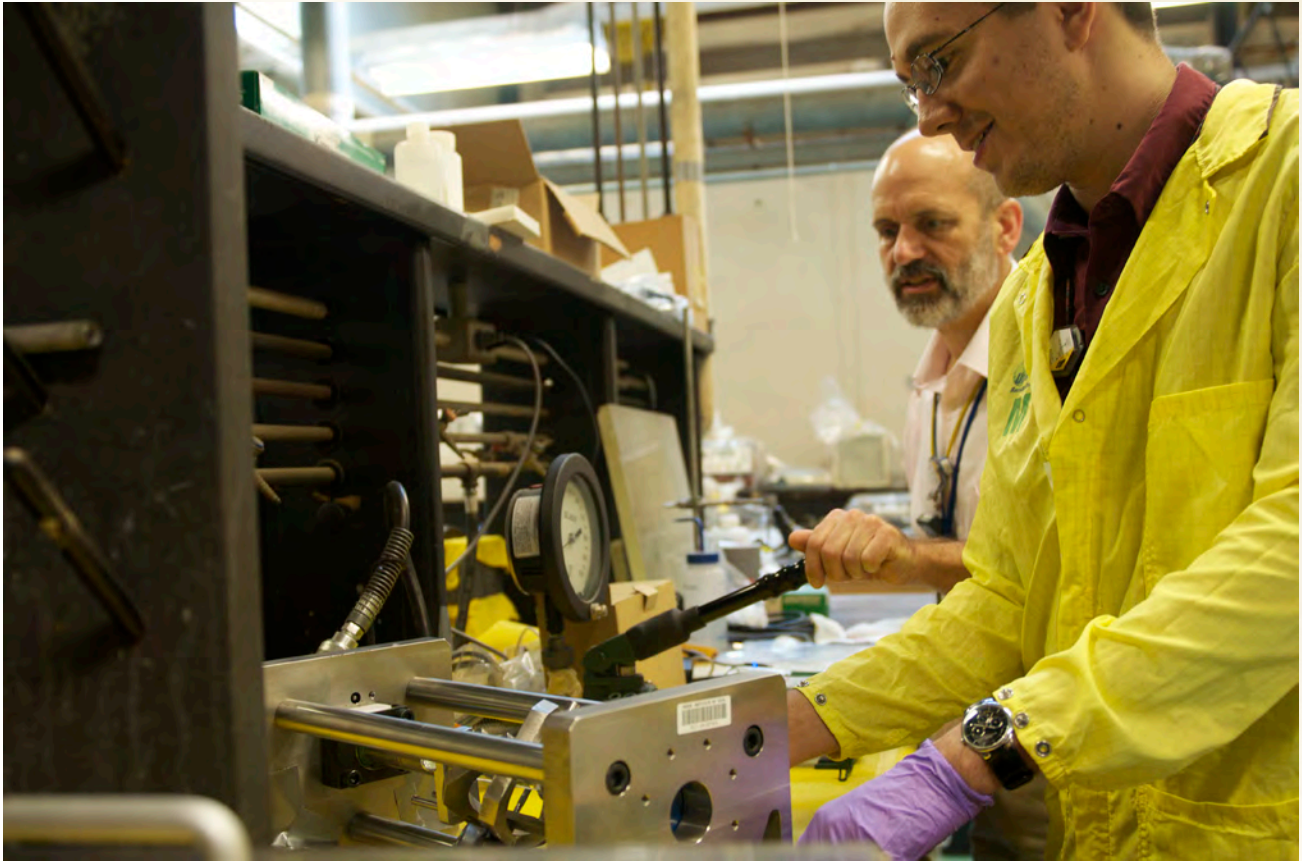

David Carpenter (bottom), and Gordon Kohse (top) removing SiC composite tube sample capsules from the irradiation rig in the reactor floor hot cell at the MITR.

Synchrotron X-ray Diffraction Study of Microstructural Evolution in Irradiated Mod.9Cr-1 Mo Steel

Principal Investigator: Meimei Li – Argonne National Laboratory
(e-mail: mli@anl.gov)

Several interesting results produced by the synchrotron XRD and XAS measurements... have raised a number of new questions.

Introduction

Mod.9Cr-1Mo ferritic-martensitic (F-M) steel is a prime candidate for structural applications in advanced reactor concepts. The initial microstructure of the alloy consists of tempered martensite stabilized by $M_{23}C_6$ carbides and a fine distribution of vanadium/niobium carbon-nitride (MX) precipitates, which give rise to superior performance. However, irradiation can significantly change the initial optimum microstructure of the alloy and degrade its mechanical properties.

In order to fully understand these effects, synchrotron X-ray diffraction (XRD) experiments were proposed to characterize phase changes and strain evolution, and their dependence on irradiation dose. These experiments are essential to understanding the fundamental mechanisms of how radiation affects advanced ferritic alloys and provide valuable experimental information for developing radiation-resistant materials.

Project Description

This collaborative project between the Argonne National Laboratory (ANL), the Illinois Institute of Technology (IIT), and the Los Alamos National Laboratory (LANL) was initiated in 2009, with the objective of exploring the viability of using synchrotron radiation techniques in characterizing radiation damage in a class of ferritic steels.

Synchrotron radiation is rapidly gaining interest as a method to characterize irradiated nuclear fuels and reactor materials, and promises to provide valuable insight into future applications for nuclear materials research. For example, previous electron microscopy studies indicated carbide amorphization and/or nonocrystallinity in irradiated mod.9Cr-1Mo steel, while synchrotron x-ray absorption spectroscopy (XAS) measurements showed a significant reduction in the coordination number of neighboring atoms as radiation doses increased.

Accomplishments

Specimens provided by the ATR NSUF from its Pre-irradiated Sample Library were proton irradiated to 1-10 displacements per atom (dpa) at 32-57° C to a mixed proton and spallation neutron flux at the Los Alamos Neutron Science Center (LANSCE).

In 2010, extended x-ray absorption fine structure (EXAFS) measurements were performed on a mod.9Cr-1Mo F-M steel irradiated to 1, 4 and 10 dpa. Irradiation-induced local changes of atomic environments associated with each alloying element were detected. These findings are important in understanding the roles of alloying elements in radiation-induced segregation and void swelling, and provide valuable insight into the design of radiation-resistant materials.

During 2011, synchrotron XRD measurements were conducted on the irradiated and irradiated-annealed mod.9Cr-1Mo specimens. The thermal annealing experiment was carried out in the Irradiated Materials Laboratory at ANL, where three specimens irradiated to 1, 4 and 10 dpa were annealed at 400° C for one hour, and three like specimens were annealed at 550° C for one hour.

In August 2011, nine irradiated and irradiated-annealed specimens were individually sealed in triple-contained sample holders and transferred to ANL's Advanced Photon Source (APS), where synchrotron XRD measurements were performed at the APS MRCAT beamline 10-ID. As shown in Figure 1, the diffraction peaks associated with $Cr_{23}C_6$ carbides disappeared after irradiation to 1 dpa. This finding is consistent with the transmission electron microscopy (TEM) observation of carbide amorphization in the proton-irradiated mod.9Cr-1Mo steel. Post irradiation annealing up to 550° C had no effect on this phase transformation.

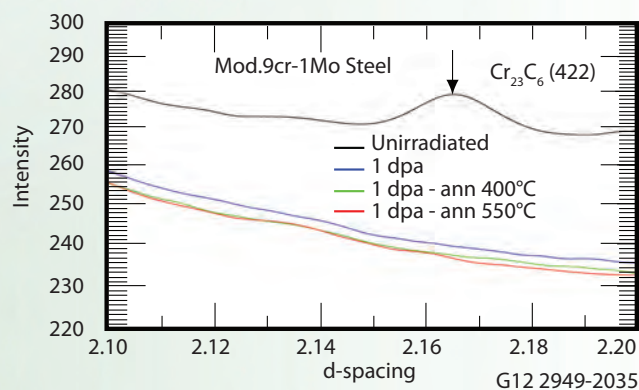
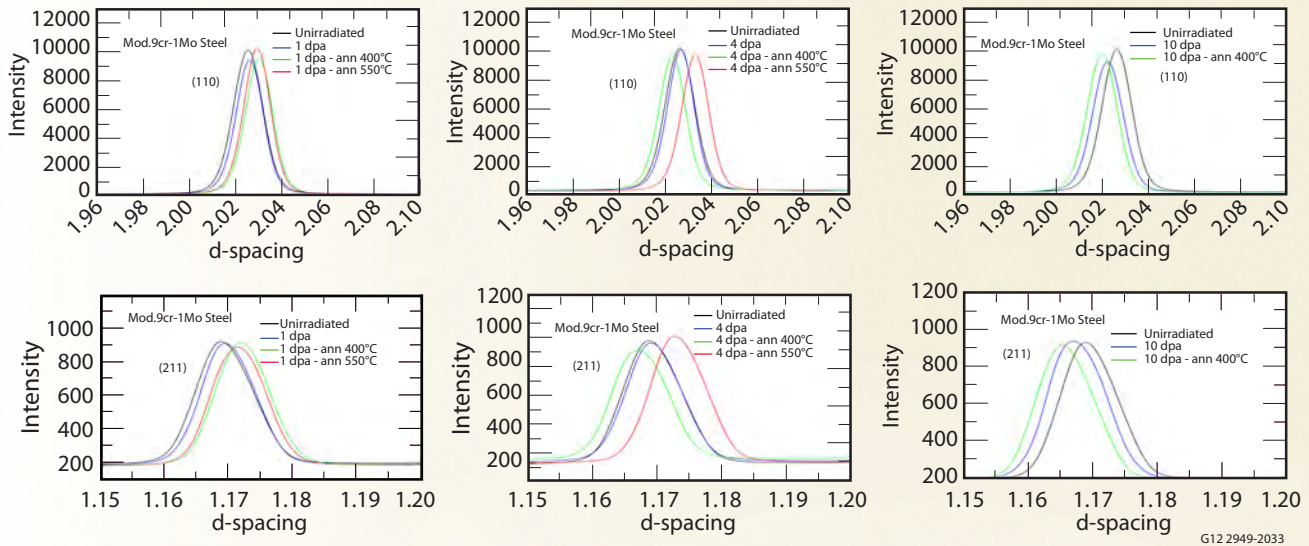

Figure 1. X-ray diffraction measurements of irradiated and irradiated-annealed mod.9Cr-1Mo steels showed the disappearance of $Cr_{23}C_6$ carbide diffraction peaks after irradiation to 1 dpa. Post-irradiation annealing showed no effect on the phase transformation.

Another significant finding was the shift of diffraction peaks associated with the ferrite (martensite) in the irradiated and irradiated-annealed specimens (Figure 2). After irradiation to 10 dpa, the lattice parameter of the ferrite (martensite) increased in the



G12 2949-2033

Figure 2. – Synchrotron XRD measurements of the irradiated and irradiated-annealed mod.9Cr-1Mo steel specimens showed peak shifts after irradiation and post irradiation annealing.

1 dpa specimens, while in the 4 dpa specimens it decreased after annealing at 400°C and increased after annealing at 550°C. The 10 dpa irradiated specimens showed further decrease in lattice parameter after post-irradiation annealing at 400°C. No significant peak broadening was observed in any of the irradiated specimens. However, peak shifting without broadening in the irradiated and irradiated-annealed specimens indicated the development of homogeneous strain due to irradiation and thermal annealing. Further study is needed to understand these phenomena.

Future Activities

This project has demonstrated that synchrotron radiation can provide unique insight into radiation damage in nuclear reactor materials. However, several interesting results produced by the synchrotron XRD and XAS measurements on proton-irradiated mod.9Cr-1Mo specimens and post irradiation annealed specimens have raised a number of new questions. Further detailed study by synchrotron radiation and electron microscopy is needed to better understand the irradiation damage and damage recovery, and to correlate the microstructural evolution with mechanical property data in the literature.

Publications

1. Meimei Li, Yulia Trenikhina, Dan Olive, Hasitha Ganegoda, Jeff Terry and Stuart A. Maloy, “Study of Irradiated Mod. 9Cr-1Mo Steel by Synchrotron XAS,” *ANS Transactions*, June 2010.
2. Meimei Li, Yulia Trenikhina, Dan Olive, Hasitha Ganegoda, Jeff Terry and Stuart A. Maloy, “Study of Irradiated Mod. 9Cr-1Mo Steel by Synchrotron XAS,” *Journal of Nuclear Materials* (in review).

Distributed Partnership at a Glance
ATR NSUF & Partners—Facilities & Capabilities
Illinois Institute of Technology —Materials Research Collaborative Access Team at the Advanced Photon Source
Idaho National Laboratory —Pre-irradiated specimen samples
Team Members/Collaborators
Argonne National Laboratory Meimei Li (principal investigator)
Illinois Institute of Technology Jeff Terry (collaborator), Dan Olive, Hasitha Ganegoda, Tim McNamee (graduate students)
Los Alamos National Laboratory Stuart Maloy (collaborator)

Atomic Scale Analysis of Oxide Dispersion Strengthened Steels Before and After High Dose Ion Implantation

Introduction

Oxide dispersion strengthened (ODS) steels are considered viable candidates for use as structural materials in Gen IV fission reactors. Providing reliable tools and insightful knowledge on the behavior of ODS steels under irradiation will advance the existing prediction models and is an essential step in support of the Department of Energy's objective of developing the safe, secure and sustainable expansion of nuclear energy.

A comparison of the oxide distribution before and after high-dose irradiation provided key information on the stability of these microstructures.

Project Description

The proper design of ODS alloys requires a detailed understanding of the relationship between processing and microstructure. At the same time, the safe use of these materials requires an understanding of their microstructural stability under irradiation. This project addressed these issues by focusing on the behavior of the nanoscale oxide particles during processing, as well as during high-dose, heavy ion irradiation. Atom probe tomography (APT) characterization was used to better understand the formation of nanoscale oxide during ball milling. The information compiled will be used to improve the processing steps needed to control the final steel microstructure. A comparison of the oxide distribution before and after high-dose irradiation provided key information on the stability of these microstructures, as well as insights into the role the nanoscale particles play in improving the radiation resistance of these steels.

Accomplishments

This short project demonstrated the impact of atom probe tomography in understanding microstructural evolution after high dose irradiation. The oxide particles in ODS steel clearly undergo transformations that are important to

understand in terms of changes in mechanical properties and impact on defect evolution (Figure 1). There were two primary accomplishments in 2011:

1. Evolution of the oxide nanoclusters during consolidation.

Materials were provided by the French Atomic Energy Commission (CEA), and ATP analyses were performed at the University of Michigan (UM). In March 2011, researchers traveled to the Center for Advanced Energy Studies (CAES) in Idaho to prepare specimens from powder flakes. However, the focused ion beam (FIB) was not working properly due to vibration issues with the micromanipulator, so specimens were prepared and analyses performed at Camica Instruments and at the UM. Results included:

- Small clusters (<1nm) containing oxygen (O) and titanium (Ti) were found in the powder flakes
- The typical larger O-, Ti-, yttrium (Y)-rich clusters were found in the consolidated material.

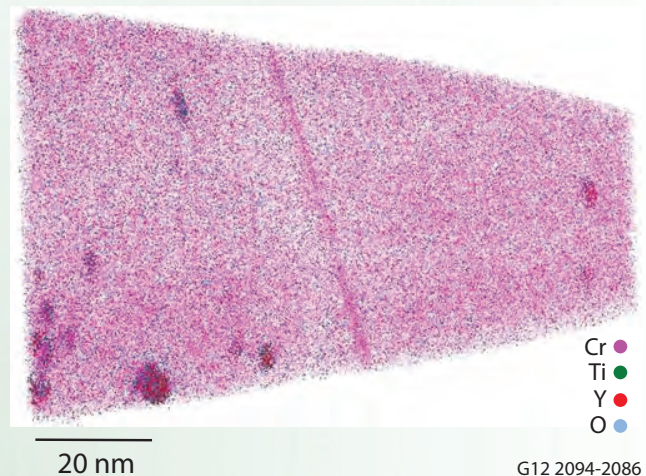

Figure 1. 3D reconstruction from an ODS steel showing Cr segregation at a grain boundary and the presence of oxide nanoparticles.

These analyses uniquely demonstrated the complexity of the oxide particles and their behavior under irradiation.

Emmanuelle Marquis, Assistant Professor, Materials Science and Engineering, University of Michigan

2. Evolution of oxide nanoclusters during irradiation.

Materials were again provided by CEA, with specimen preparation and ATP analyses taking place at the UM. By the time this work began, a reliable FIB access had been obtained within driving distance of Michigan, and a LEAP 4000X HR atom probe microscope had been installed at the UM. As a result, all work was performed at UM. A sample of $\text{Fe}_{18}\text{Cr}_1\text{WO}_{0.4}\text{Ti-Y}_2\text{O}_3$ was analyzed before and after ion implantation to 200 displacements per atom (dpa). Results included:

- Composition of the particles evolved from Y:Ti=1:1 before irradiation to Y:Ti=2:1 after irradiation.
- The chromium (Cr) level in the particles decreased after irradiation.

Future Activities

The project is now complete.

Distributed Partnership at a Glance
ATR NSUF & Partners—Facilities & Capabilities
Idaho National Laboratory —Center for Advanced Energy Studies MaCS Laboratory
Team Members/Collaborators
University of Michigan Emmanuelle Marquis (principal investigator), Yimeng Chen (collaborator)
Commissariat à l’Energie Atomique Yann de Carlan, Marie-laure Lescoat, Joel Ribis (collaborators)

Influence of Fast Neutron Irradiation on the Mechanical Properties and Microstructure of Nanostructured Metals/Alloys

Introduction

With the spiraling rise in energy demand across the world and the imminent depletion of traditional energy reserves, the need for alternative energies, especially from renewable resources, is becoming ever more relevant and pressing. Currently, nuclear energy presents a compelling, environmentally friendly energy source that can be trusted to meet these growing demands. Furthermore, there is a growing interest in developing a new generation of advanced nuclear energy systems, both fission and fusion, designed to operate at higher temperatures and extremely high radiation levels.

Accordingly, developing materials that are highly resistant to intense radiation fluxes has become an essential goal. The effect of radiation exposure on nanostructured metals is of immense interest, both from scientific and technological points of view.

Project Description

The goal of this experiment is to study the basic effects of neutron irradiation on nanostructured metals and alloys.

It is well known that irradiation-induced point defects and their clusters can migrate and annihilate at the interfaces between materials. Accordingly, because the large volume of their grain boundaries can act as important sinks for radiation-induced defects, nanostructured metals should possess good resistance to irradiation.

The response of nanostructured metals to neutron irradiation can be expected to be different from their large-grained equivalents. This post-neutron irradiation response could take the form of changes in the material's mechanical properties or an altogether altered microstructure.

The harsh radiation environments expected in the new generation of nuclear systems triggered the search for high-radiation-tolerant materials that function efficiently under these severe conditions.

Accomplishments

Post-irradiation examination (PIE) of nanostructured copper (Cu) along with conventional Cu is in the final

Distributed Partnership at a Glance
ATR NSUF & Partners—Facilities & Capabilities
Idaho National Laboratory —Advanced Test Reactor, PIE facilities
North Carolina State University —PULSTAR Reactor
Team Members/Collaborators
North Carolina State University K.L. Murty (principal investigator), Walid Mohamed (Ph.D. student)
Idaho National Laboratory Doug Porter (co-principal investigator)
University of Idaho Indrajit Charit (co-principal investigator), Ramprashad Prabhakaram, (Ph.D. student)

phase. Mechanical testing and hardness measurements were completed in the summer of 2011, while microstructure investigation to determine the grain size of the irradiated samples is in progress.

While grain size measurement was easily carried out at North Carolina State University, preparing transmission electron microscopy (TEM) foils for PIE at INL's Materials and Fuels Complex (MFC) has taken much longer than expected, which has put the project behind the schedule. PIE of nanostructured copper (Cu) along with its conventional counterpart is in its final phase, while mechanical testing and hardness measurements were completed in the summer of 2011.

The results of these tests suggest that the response of nanostructured Cu to fast neutron irradiation is controlled primarily by two mechanisms:

- Irradiation-induced grain growth, which is dominant at a relatively low damage level [0.34 displacements per atom (dpa)]
- Irradiation hardening at a higher damage level (2.0 dpa).

The two mechanisms seem to be competing at 1 dpa (Figure 1). On the other hand, micrograined Cu underwent irradiation hardening at all damage levels, manifesting itself as an increase in strength and a decrease in ductility (Figure 2).

Microstructure investigation of nanostructured Cu at 1 dpa (Figure 3) and 2 dpa (Figure 4) showed the formation of the annealing twin structure that is usually observed in grain growth. On the other hand, the microstructure of conventional Cu exhibits more dislocation structure at both damage levels (Figure 5).

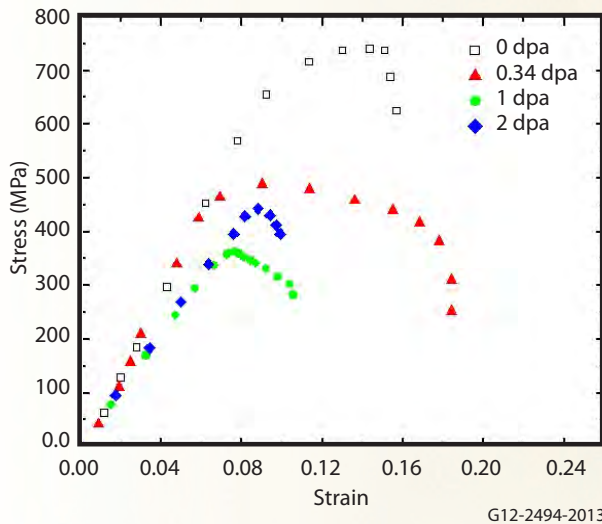

G12-2494-2013

Figure 1. Stress-strain curves of irradiated nanostructured copper at different damage levels. In-reactor grain growth is dominant at 0.34 dpa in terms of decrease of strength and increased ductility while at 2 dpa, material response is suggested to be controlled by irradiation hardening.

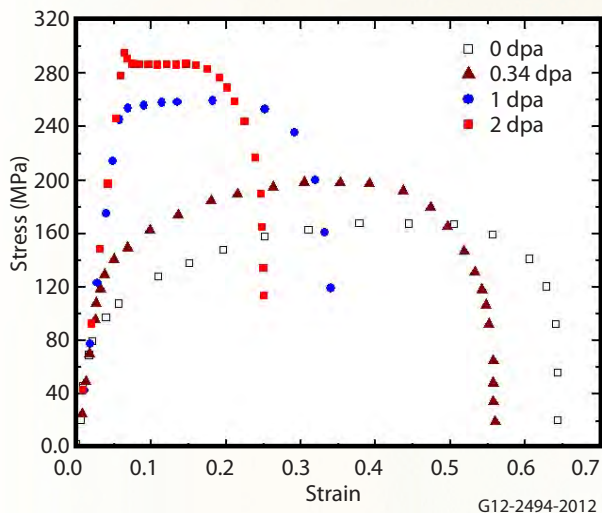

G12-2494-2012

Figure 2. Stress-strain curves of irradiated micrograined copper showing irradiation hardening at all damage levels.

Researchers also observed a twin structure similar to that which formed in its nanostructured counterpart (see Figure 6).

The difference in the response of nanostructured Cu to an applied tensile load, compared to that of its conventional counterpart, suggests the need for further TEM investigation of the deformed tensile samples.

Future Activities

Measurement of grain size in irradiated samples using a scanning electron microscope (SEM) with the TEM foils is planned. Preparing TEM foils of deformed tensile samples is also planned.

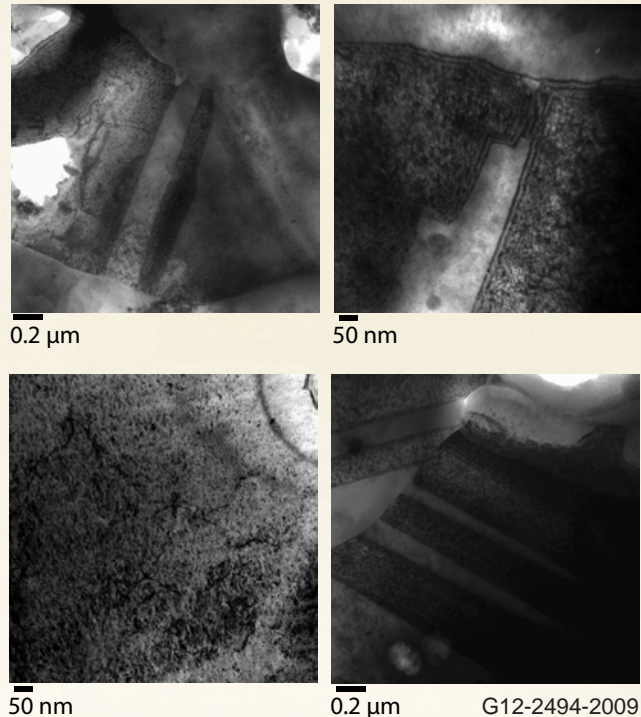

G12-2494-2009

Figure 3. Annealing twins observed in nanostructured copper at 1 dpa (top left). Figure 4. Dislocation structures observed in nanostructured copper at 2 dpa (top right). Figure 5. Microstructure of irradiated micrograined copper showing the formation of dislocations causing radiation hardening (bottom left). Figure 6. Twin structure observed in micrograined copper (bottom right).

Publications and Presentations

1. Walid Mohamed, Jacob Eapen, Douglas Porter, K. L. Murty, "Effect of Neutron Radiation on Mechanical Properties of Nanograin Structured Copper," Material Science & Technology (MS&T) 2011 Annual Conference & Exhibition, October 2011, Columbus, Ohio, USA.
2. Walid Mohamed, Jacob Eapen, K. L. Murty, "Mechanical Behavior of Nanograin Structured Metals – Effect of Neutron Irradiation," International Conference on Nanoscience, Nanotechnology & Advanced Materials (NANOS 2010), December 2010, Rushikonda, Visakhapatnam Andhra Pradesh, India.
3. Walid M. Mohamed, K. L. Murty, "Influence of Fast Neutrons Irradiation on Nanocrystalline Materials," The Materials Science & Technology Conference and Exhibit (MS&T '08), October 2008, Pittsburgh, Pennsylvania, USA.
4. Walid Mohamed, Jacob Eapen, and K. L. Murty. "Mechanical Properties and Developed Microstructure of Irradiated Nanostructured Copper." In preparation.

Irradiation of Potential Inert Matrix Materials

The world has long been faced with a difficult question in the area of nuclear waste. How do we safely and securely dispose of our ever-expanding stockpile of weapons- and reactor-grade radiotoxic nuclear waste in ecologically responsible and economically viable ways? As the volume of the waste and the speed at which it is produced grows, finding the answer becomes an ever-more urgent national and international priority.

On the surface, it appears we already have one answer to the problem: transmutation of plutonium (Pu), neptunium (Np), americium (Am), curium (Cm), and other nuclear byproducts in atomic reactors. This long-accepted method converts the radioactive constituents of the waste into more stable materials, such as iodine (^{131}I), barium (^{140}Ba), and Cerium (^{140}Ce). However, in some cases, this solution can be almost as harmful as the original problem. For example, in the case of mixed-oxide-based (MOX) fuels, which themselves are composed of weapons-grade plutonium (PuO_2UO_2), transmutation leads to the generation of new radioactive transuranium actinides.

A more promising alternative is burning the Pu and other transuranic elements in an inert-matrix fuel (IMF), which generates far less radioactive waste. The project activities described in this report are focused on the development of such a fuel.

Project Description

For this project, university researchers investigated the thermophysical properties and synthesis of magnesium oxide-neodymium zirconate cerceer composites ($\text{MgO-Nd}_2\text{Zr}_2\text{O}_7$) and single-phase magnesium-based spinel compounds.¹

The objectives of the project are three-fold:

- Investigate the behavior of $\text{MgO-Nd}_2\text{Zr}_2\text{O}_7$ cerceer composites when used as inert matrices in irradiated environments
- Investigate the behavior of single-phase, Mg-based spinel compounds as inert matrices in irradiated environments
- Characterize the effects of irradiation on the microstructure and thermophysical properties of the irradiated materials.

Ceramic disc samples were irradiated at approximately 350 and 700°C to dose accumulations of 2 displacements per atom (dpa) and 4 dpa (Table 1). The increases in irradiation doses from the 1 dpa and 2 dpa estimated values of past years to the current 2 dpa and 4 dpa were based on new calculations of post-reactor conditions.

Table 1. Irradiated materials and capsule irradiation conditions.

Materials	Capsule Identification		
	Dose (dpa)	Temperature (°C)	
$\text{MgO} \cdot 1.5\text{Al}_{14}\text{O}_3$		2	350°
MgAl_2O_4	A2		B2
MgO	4	C2	C1
$\text{Nd}_2\text{Zr}_2\text{O}_7$			
$0.7\text{MgO}-0.3\text{Nd}_2\text{Zr}_2\text{O}_7$			
Mg_2SnO_4			

To understand the behavior of these materials under irradiation, the researchers are subjecting them to post-irradiation examination (PIE) at the INL's Materials and Fuels Complex.

Accomplishments

In December 2010, capsules C1 and C2 were disassembled and their samples were categorized at the Hot Fuel Examination Facility. Post-irradiation examination of samples from the capsules began in May 2010 at the INL, joining samples from capsule A2 that were already in PIE.

X-ray diffraction (XRD) of MgO pellets was performed at the INL's Fuel and Applied Science Building. The resulting XRD patterns, as shown in Figure 1, indicate that no phase change or amorphization occurred due to irradiation.

To further characterize the irradiation damage, transmission electron microscopy (TEM) was performed. Samples were prepared using a focused ion beam (FIB)

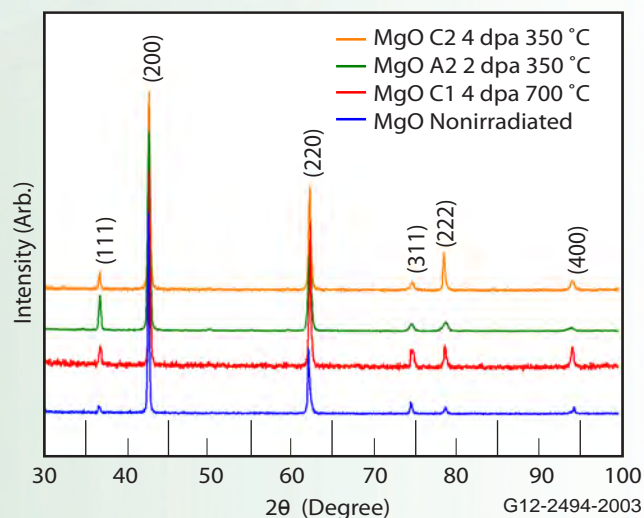

Figure 1. XRD of MgO indicates the material did not become amorphous after irradiation and the crystal structure did not change.

It is critical to our goal of developing safer ways of disposing of nuclear waste to understand how varying degrees of irradiation damage affect the material properties of these inert-matrix candidates. By analyzing these oxides under different irradiation conditions, we have been able to verify or disprove the theoretical hypotheses we held at the beginning of the project.?

Donald Moore, Graduate Student, University of Florida

Developing inert matrix fuels will reduce radiotoxic waste and thus provide the world with a sustainable fuel cycle.

(Figure 2A) then characterized using TEM at the Electron Microscopy Laboratory. TEM images of MgO show that a high density of small dislocations occurred at the lower irradiation temperatures (Figures 2b and 2d). The dislocation density increased with the higher irradiation dose, while the higher irradiation temperature leads to a lower density of larger dislocations (Figure 2c).

TEM also revealed the presence of ~1 nm voids that formed at the higher irradiation temperature. MgO samples were thermally annealed at 1400°C for one hour, prepared through FIB, and then examined by TEM. Annealing of the samples caused the 1 nm voids to coalesce and reduced the irradiation damage. TEM was also performed on the Mg₂SnO₄ and MgO-Nd₂Zr₂O₇ samples from capsule A2.

Thermal diffusivity measurements of MgO taken at the Analytical Laboratory using the laser flash technique show that diffusivity decreased due to irradiation damage. In Figure 3, the thermal diffusivity of non-irradiated MgO is compared to MgO irradiated under different conditions. MgO from the A2 and C2 capsules have the most significant reductions in thermal diffusivity. This is caused by the high density of small dislocations in the samples. However, increasing the irradiation dose produces little change.

At higher temperatures, the difference in thermal diffusivity between irradiation conditions decreases. MgO from the C1 capsule, which was irradiated at a high temperature, showed an intermediate decrease in thermal diffusivity. This is due to the lower density and larger size of the dislocations. When heated, the MgO samples from A2 and C2 began to anneal and recover thermal diffusivity to the level of the C1 MgO.

In the previous year, radiation work was suspended at the Materials and Fuel Complex, which slowed the research team's progress. Nonetheless, the team was able to complete characterization of the effects of irradiation on the microstructure and thermophysical properties of MgO.

Research to be completed

Upcoming research will focus on MgAl₂O₄, Mg₂SnO₄, and MgO-Nd₂Zr₂O₇ samples from capsules C1 and C2.

This will complete the remaining project objectives.

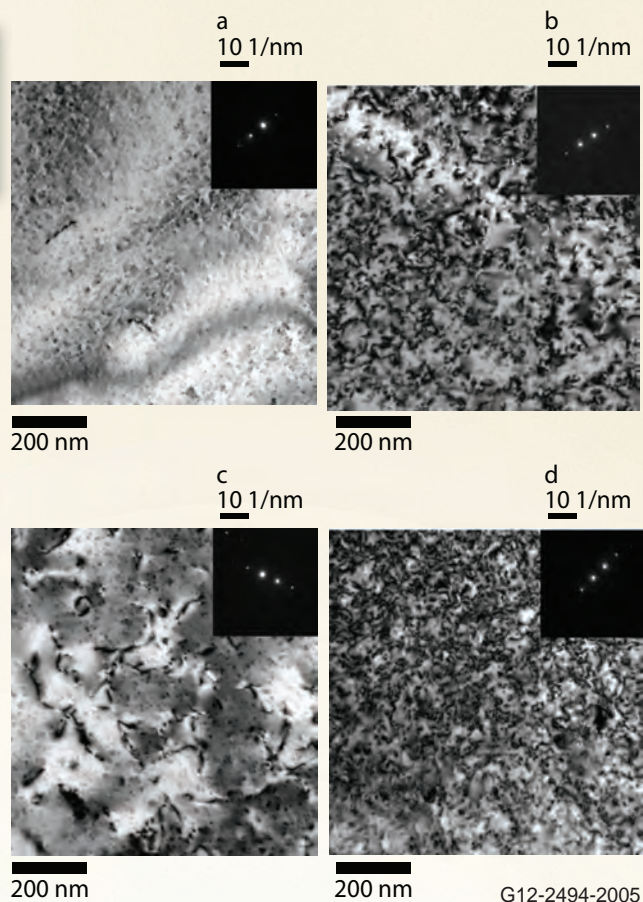

Figure 2. Results of MgO TEM. Figure 2a: Minimal ion damage due to the FIB in non-irradiated MgO. Figure 2b: High-density TEM of small dislocation loops due to neutron irradiation in A2 MgO. Figure 2c: C1 MgO has a lower density of larger dislocations due to the higher irradiation temperature. Figure 2d: C2 MgO has a higher density of dislocations compared to A2 MgO because of the larger irradiation dose. Each TEM image is in the $g = [200]$ two-beam diffraction condition.

The planned project activities are:

- Characterize defect formation in neutron-irradiated materials
- Characterize irradiation damage, voids, and other deteriorative microstructural features using TEM
- Measure thermal diffusivity of irradiated samples and correlate them with radiation doses, radiation temperature, and defect formation
- Study the mechanism of thermal diffusivity degradation.

The planned experiments for this project are:

- Diffusivity measurements of MgAl₂O₄, Mg₂SnO₄, and MgO-Nd₂Zr₂O₇ from capsules A2, C1, and C2

Irradiation of Potential Inert Matrix Materials (cont.)

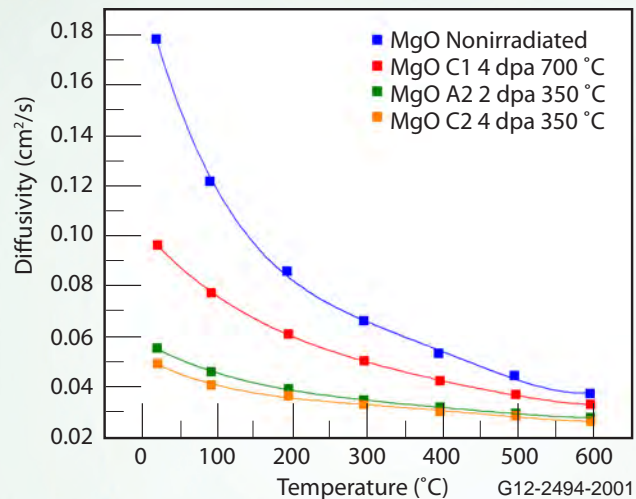

Figure 3. Thermal diffusivity of non-irradiated MgO compared to MgO irradiated under different conditions. Both MgO A2 and C2 show the most significant reductions in thermal diffusivity due to the high density of small dislocations, but there is little difference when the irradiation dose is increased. C1 irradiated at high temperature has an intermediate decrease in thermal diffusivity because of the lower density and larger size of the dislocations.

- TEM and SEM of MgAl₂O₄, Mg₂SnO₄, and MgO-Nd₂Zr₂O₇ from capsules C1 and C2
- TEM of annealed MgAl₂O₄ from capsules C1 and C2.

The research team also hopes to accomplish the following:

- Use PIE to compare the effects of irradiation dose and temperature on the properties of MgO-Nd₂Zr₂O₇ and Mg₂SnO₄ from capsules C1 and C2
- Determine the effect of crystal structure and atom size on the radiation resistance of spinel by comparing the irradiation damage in Mg₂SnO₄ to that in irradiation-resistant MgAl₂O₄
- Compare the irradiation behavior of MgO to that of the cercer composite MgO-Nd₂Zr₂O₇.

Publications

1. 2009: "Irradiation of Potential Inert Matrix Materials: ATR-NSUF University of Florida Experiment." ATR-NSUF User Week, INL, Idaho Falls, Idaho, June 2, 2009.
2. 2010: "Investigation of MgO-Pyrochlore Composites and Spinel Compounds as Potential Inert Matrix Materials." INL Colloquium, ATR-NSUF, Idaho Falls, ID, May 20, 2010.

Distributed Partnership at a Glance
ATR NSUF & Partners—Facilities & Capabilities
Idaho National Laboratory—Advanced Test Reactor, PIE facilities
Team Members/Collaborators
University of Florida Juan C. Nino (principal investigator), Donald Moore (graduate student)
Idaho National Laboratory Pavel Medvedev (co-principal investigator), Brandon Miller (collaborator),

Reference

- [1] Nino, J. C. NERI final technical report DE-FC07-O5ID14647: "Optimization of oxide compounds for advanced inert matrix materials." *Report No. DOE/ID/14647-Final* (2009).

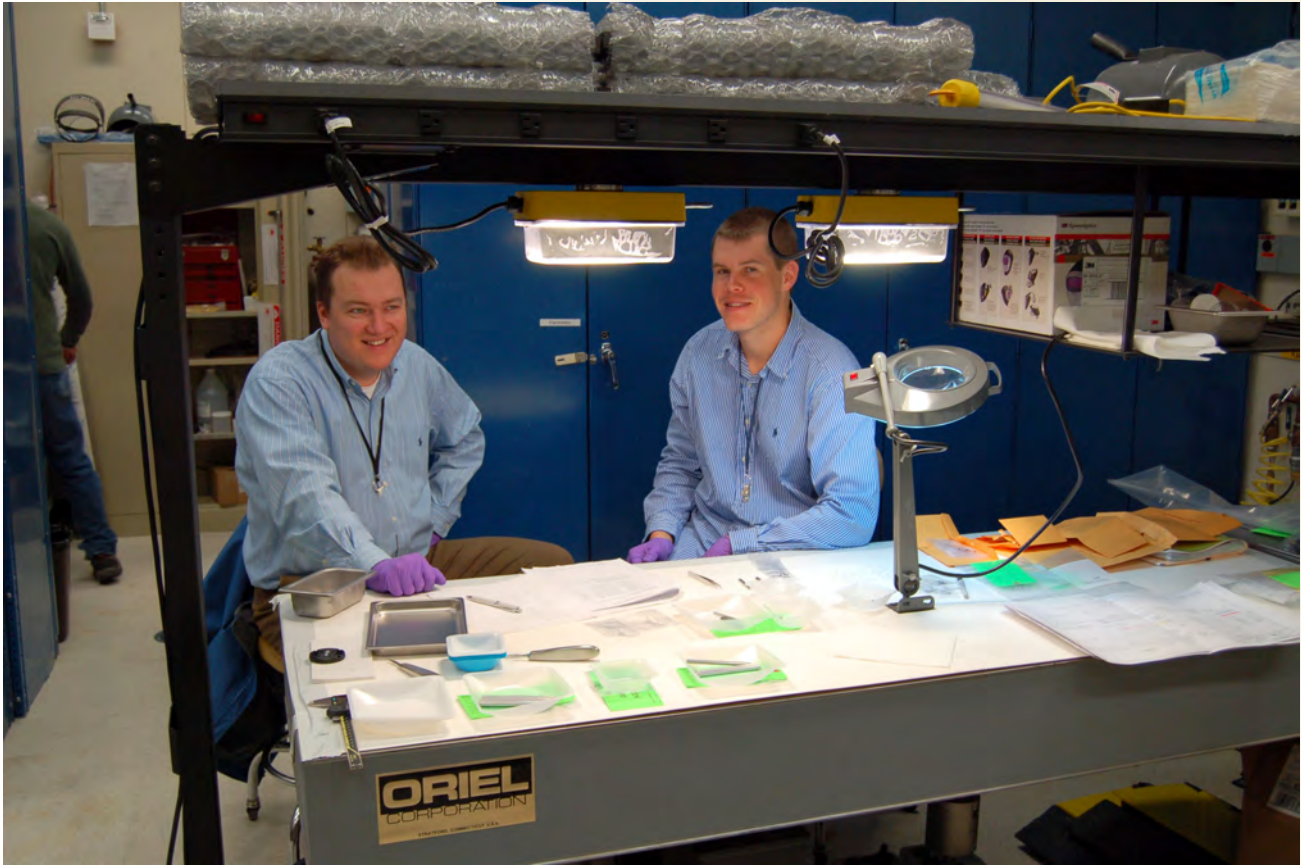

INL researcher Pavel Medvedev (left), and University of Florida graduate student Don Moore (right) load the University of Florida samples into the capsule prior to irradiation in the ATR.

Characterization of Advanced Structural Alloys for Radiation Service

Introduction

One of the many challenges in developing advanced sources of nuclear energy is overcoming the deleterious effects of radiation damage on advanced fission and fusion structural materials. To accomplish this, a better understanding is needed of the radiation-induced degradation of the mechanical properties and microstructures of these materials.

The initial PIE represents the very first steps taken in assembling a comprehensive database that will lead to a greater understanding of radiation damage to structural alloys.

Project Description

The objective of this University of California, Santa Barbara experiment is to create a large library of irradiated alloy conditions and sample types that has not existed before. It will consist of some 49 structural steels, model alloys and special mechanism specimens. The structural alloys will include: tempered martensitic steels, nonstructured ferritic alloys, stainless steel, model alloys, including Fe-Cr binary alloys and Mn-Mo-Ni bainitic reactor pressure vessel (RPV) steels, and specimens targeting specific irradiation damage mechanisms.

One goal is to build a database of irradiation hardening and softening phenomena due to irradiations from 1.5 to 6 displacements per atom (dpa) at temperatures from $\approx 290^\circ$ to 750° C. Changes in mechanical properties will be assessed by microhardness measurements and instrumented shear punch tests, supplemented by tensile tests on a subset of alloys. Irradiating 49 materials side-by-side under many conditions presents a unique opportunity that will greatly facilitate identifying, understanding, modeling and ultimately predicting and improving the behavior of materials used in nuclear energy systems.

Fracture studies using compact tension samples will be carried out on a subset of alloys in the framework of the Master Curve method to measure irradiation embrittlement. The compact tension tests will be supplemented by mini-bend bar fracture tests.

In addition, model alloys will be used to study fundamental damage mechanisms. For example, 0-to-18% chromium (Cr) iron-chromium (Fe-Cr) binary alloys irradiated over a wide range of temperatures will be used to study alloying effects on microstructures and hardness. Multi-constituent diffusion multiples or “lab-on-a-chip” specimens, will enable characterization of how various elements migrate and arrange themselves in different phases in complex alloys under irradiation. In-situ helium implantation studies will also be conducted. State-of-the-art tools will be used to relate the mechanical property tests of the irradiated materials to microstructural evolutions, based on detailed characterization studies.

The majority of the approximately 1,380 specimens are disc multi-purpose coupons, which will be used for a list of experiments that includes: microhardness, shear punch, neutron scattering, transmission electron microscopy, positron annihilation, x-ray scattering and diffraction and atom probe tomography.

The specimen matrix also includes the following specimen types: sub-sized tensile, disc compact tension fracture, deformation and fracture mini-beam, chevron notch wedge fracture, cylindrical compression.

Accomplishments

The irradiation which began at INL’s ATR in 2009 was completed in June 2010. Capsules containing 32

Distributed Partnership at a Glance
ATR NSUF & Partners—Facilities & Capabilities
Idaho National Laboratory —Advanced Test Reactor, PIE facilities
Team Members/Collaborators
University of California, Santa Barbara, G. Robert Odette (principal investigator), David Gragg, Doug Klingensmith, Takuya Yamamoto (co-principal investigators), Tim Milot (graduate student)
Idaho National Laboratory Jim Cole (co-principal investigator)
Los Alamos National Laboratory Stuart Maloy (collaborator)
Oak Ridge National Laboratory Randy Nanstad (collaborator)
Pacific Northwest National Laboratory Richard Kurtz, Mychailo Toloczko (collaborators)
University of California, Berkeley Brian Wirth (collaborator)

“The early PIE results are very exciting, but represent just the tiniest tip of the iceberg of information and insight yet to come. Just three examples are the effect of Cr on hardening with an apparent minimum at 9%Cr, the ranking of hardening found in the 9-12Cr tempered martensitic steels, and what perhaps may be a record setting level of hardening in the Mn-Ni-Cu model alloys and steels.”

G. Robert Odette, Professor, Nuclear Engineering, University of California, Santa Barbara

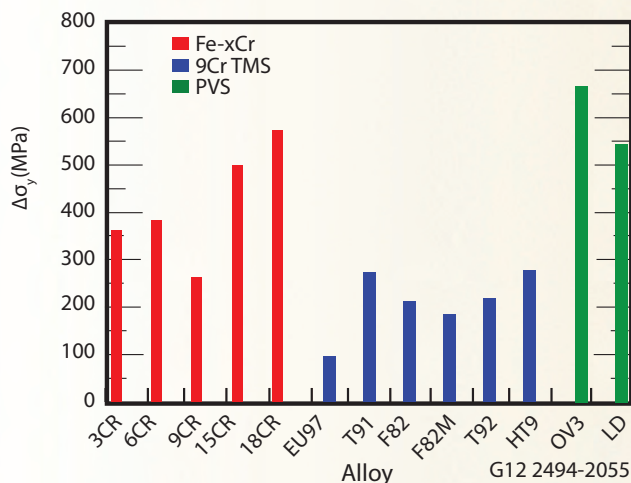

Figure 1. Examples of hardening in Fe-Cr binary alloys (red), 9Cr tempered martensitic steels (blue) and a model RPV alloy and steel (green).

isothermal temperature packets were irradiated at seven temperatures ranging from $\approx 290^\circ$ to 750° C up to a peak dose of 6 dpa. After irradiation to 1.7 dpa at 275° C, one of the capsules was opened and sorted at the INL hot cell facility.

A UCSB graduate student, in residence at the INL from July to December 2011, began PIE on the irradiated alloys at the Materials and Fuels Complex (MFC) and the Center for Advanced Energy Studies (CAES). Fourteen specimens from the first capsule were decontaminated and transferred to the INL’s Electron Microscopy Laboratory (EML). The results of microhardness measurements on twelve of these alloys are shown in Figure 1.

In the graphic, hardness changes have been converted to equivalent yield stress increases using a factor of 3.33. The red histogram bars show the effect of Cr variations in simple Fe-Cr binary alloys. The minimum hardening is observed at 9Cr, with increases as high as 15Cr and 18Cr presumably due to the precipitation of α' . The blue histogram bars represent 9Cr tempered martensitic steels. Of those, Eurofer97 exhibited the least hardening, while the T91 and HT9 were higher than the others, and nearly equal. The intermediate hardening in F82H IEA and F82H Mod3 data are in good agreement with previously established trends.

The green bars represent a simple 1.6Mn-1.6Ni OV3 RPV model alloy and a 0.4Cu, 1.3Ni, 1.4Mn LD RPV steel. The large amount of hardening in the OV3 alloy is believed to be partly due to the formation of irradiation induced Mn-Ni phases. The same effect in the LD RPV

steel is believed to be partly due to the formation of Cu-Mn-Ni phases. Microstructural characterization studies of these irradiated alloys are scheduled to be carried out in 2012.

The graduate student also designed a shear punch test fixture with 1mm and 3mm punch diameters, and worked with machinists at INL to fabricate it as shown in Figure 2. These new fixtures are being used to calibrate and validate the procedure.

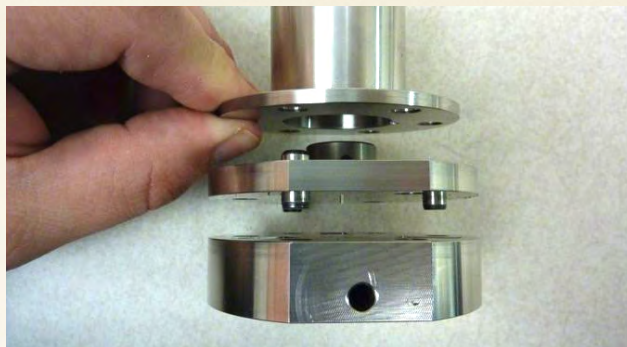
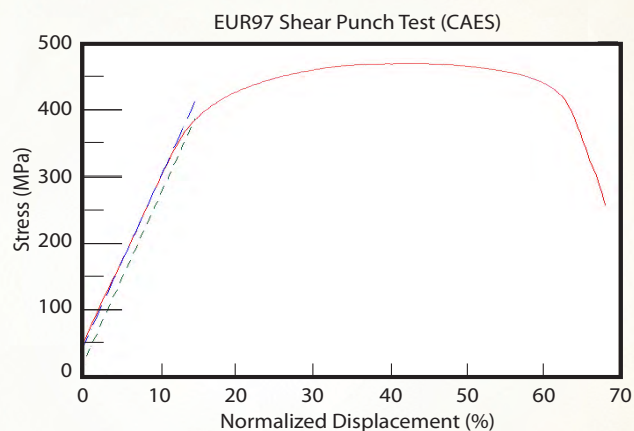

Figure 2. Side view of the shear punch fixture. G12 2494-2057

An example of a shear punch test load for Eurofer97, converted to shear yield-flow stress and the normalized displacement (shear strain), is shown in Figure 3. A one percent offset line, commonly used to mark yielding, is also shown. A large shear punch test database is being assembled to develop a standard procedure to correlate the results to tensile properties.



G12 2494-2058

Figure 3. Load displacement data converted to engineering shear stress and strain.

Future Activities

PIE and mechanical testing is scheduled to continue in 2012.

A High Fluence Embrittlement Database and ATR Irradiation Facility for Light Water Reactor Vessel Life Extension

Introduction

Demonstrating that massive light water reactor pressure vessels (RPV) can maintain large safety margins against sudden fracture will be required in order to extend nuclear plant operation up to 80 years. Neutrons that leak from the reactor core bombard the RPV and cause embrittlement, manifested as increases in the brittle fracture temperature of RPV steels. Unfortunately, there is almost no plant surveillance transition temperature shift (TTS) data for the high neutron fluence and long times experienced during extended life. Highly accelerated test reactor irradiations can reach high fluence levels of 10^{20} n/cm², but may not be reliable due to the complex effects of neutron flux and new damage mechanisms that may emerge during extended life. The UCSB ATR-2 irradiation experiment was designed to address these critical issues.

A special test rig for RPV steels was designed, fabricated and finally inserted into the ATR at the INL in June 2011. The experiment contains a comprehensive specimen/alloy/irradiation condition matrix, which will enable more accurate TTS predictions.

There is very little data on low flux transition temperature shift at high fluence levels.

Project Description

The intermediate flux ATR irradiations will bridge large gaps in the existing embrittlement database. The experimental matrix consists of 172 different RPV steels, in the form of disc multi-purpose coupons, disc

compact tension fracture specimens and sub-sized tensile specimens. The irradiations cover the temperature range from 250 to 310°C up to a fluence of 10^{20} n/cm². The high fluence intermediate flux database will be linked to other test reactor and surveillance data over a much wider range of flux. These data will be used to inform, validate and calibrate predictive, physically-based TTS models.

The objectives of the experiment include:

- Assessing the effects of flux and the synergistic interactions between all embrittlement variables
- Use of post irradiation annealing to evaluate the effects of flux and other embrittlement variables on the various types of radiation induced nm-scale features that cause TTS
- Identifying conditions leading to the formation of “late-blooming” phases that could lead to severe embrittlement that is not treated in current regulatory models
- Extensive microstructural characterization and mechanism studies
- Evaluating annealing as a potential embrittlement mitigation strategy
- Irradiating new RPV alloys, including candidates for use in advanced reactors
- Evaluating the master curve method for measuring fracture toughness at high fluence in sensitive alloys
- Addressing issues associated with uncertainties in the alloy conditions in the actual vessel.

Accomplishments

The new irradiation test rig was designed jointly by researchers at the University of California, Santa Barbara (UCSB) and INL. Prior to final assembly, mock-up experiments were performed to verify the thermal design. A cross section of the capsule design is shown in Figure 1 and a picture of the thermocouple and gas feed assembly is shown in Figure 2.

A major specimen fabrication program was completed at UCSB in parallel with the test rig activity at INL. The irradiation included RPV steels from UCSB, Oak Ridge National Laboratory, Rolls Royce Marine Power, Bettis Atomic Power Laboratory, the Japanese Central Research Institute of the Electric Power Industry, and several U.S. utilities. The specimens were

Distributed Partnership at a Glance
ATR NSUF & Partners—Facilities & Capabilities
Idaho National Laboratory —Advanced Test Reactor, PIE facilities
Team Members/Collaborators
University of California, Santa Barbara G. Robert Odette (UCSB principal investigator)
Idaho National Laboratory Mitch Meyer (INL principal investigator)
Oak Ridge National Laboratory Randy Nanstad (Collaborator)
Bettis Atomic Power Laboratory M. G. Burke (Collaborator)
Rolls Royce Marine T. Williams (Collaborator)
Japanese Central Research Institute of the Electric Power Industry N. Soneda (Collaborator)

Our collaboration with the INL scientists and engineers involved in the design and construction of UCSB ATR-2 irradiation facility has been an outstanding experience. Notably, ATR-2 is currently the only experiment of its kind in the world, and is among the most comprehensive of all time. The information and insight derived from this research will make an enormous contribution to safe light water reactor life extension.

G. Robert Odette, Professor, Nuclear Engineering, University of California, Santa Barbara

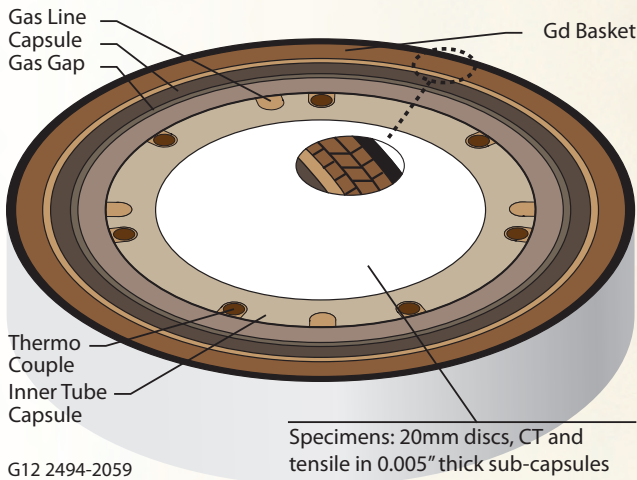

G12 2494-2059

Figure 1. Cross section of the UCSB ATR-2 test assembly.

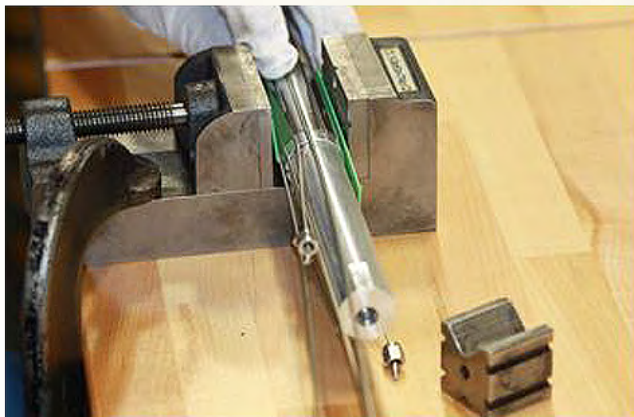

Figure 2. The thermocouple and gas feed assembly.

G12 2494-2060

precision machined and laser engraved for easy identification.

In March 2011, a set of 13 precision specimen holders were delivered to UCSB by an INL quality control engineer, who supervised the subsequent loading of 1,624 specimens. The loaded holders were returned to

INL, where final test rig assembly was completed. The test rig was inserted into ATR position I-10 on schedule, in April 2011. Irradiation began in early June 2011, and temperature monitoring and control systems have performed well up to the end of the reporting year.

As shown in Figure 3, the specimen temperature estimates, based on thermocouple readings extrapolated by calculation to the specimen center, fell within a reasonable range of the nominal target temperatures: 255, 270, 290 and 310° C at a peak flux of $\approx 3.8 \times 10^{12}$ n/cm²-s and a peak target fluence of $\approx 9 \times 10^{19}$ n/cm².

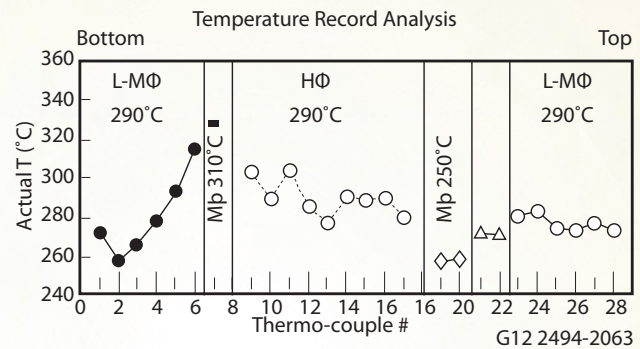
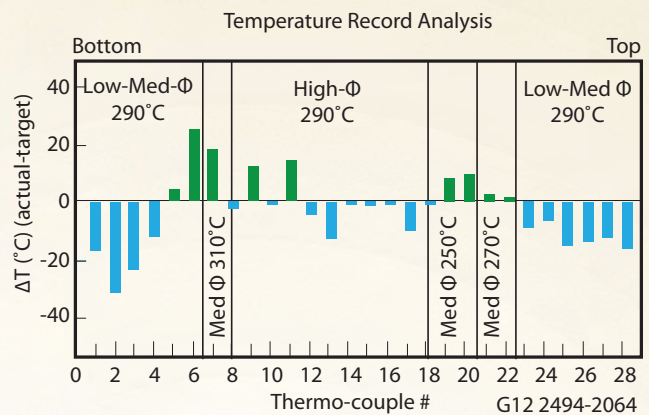

Figure 3. Actual temperature deviations from the calculated set points showing excellent overall thermal performance.

Future Activities

Irradiation with ongoing temperature monitoring is scheduled to continue through August 2012. Once complete, a report on the irradiation phase of the program will be prepared, and PIE activities will be initiated.

Light Water Reactor Hydride Fuel Irradiation Experiment

Introduction

The use of hydride fuel for power production in the current fleet of light water reactors (LWRs) has been shown in laboratory scale experiments¹ to provide a number of improvements over the use of mixed oxide fuels (MOX). In addition to eliminating plutonium, the thermally-induced hydrogen up-scattering that accompanies Doppler Feedback and the addition of hydrogen neutron moderation within the fuel promotes improved safety and higher fuel efficiency. Furthermore, the use of liquid metal (LM) as a replacement for helium in the fuel-cladding gap assists in lowering the temperature of the fuel.

Recognizing the necessary shift from the laboratory to more relevant environments, fuel irradiation experiments are being undertaken at the Massachusetts Institute of Technology research reactor (MITR) to realistically assess the performance of pressurized water reactors (PWR) using solid hydride fuels.

Moving fueled experiments from the laboratory to relevant environments.

Project Description

After fabricating five mini-fuel rod assemblies at the University of California, Berkeley in 2009, four with LM and one with a helium-filled gap to act as a control, researchers inserted them into the MITR in 2010 for irradiation. Prior to insertion, the assemblies were

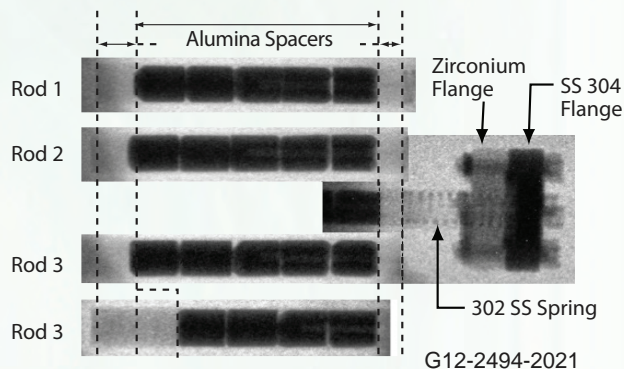

Figure 1. Neutron radiographs of four liquid metal gap filled fuel rod assemblies.

examined by neutron radiography to ensure the fuel pellets were properly stacked (Figure 1). However, the images revealed no contrast between the LM and Zircoloy cladding, and the probable existence of gas bubbles within the LM gap could not be confirmed, possibly due to the 100 μ m resolution limit of the instrument.

The capsule was designed to perform the following functions:

- Act as a fission product release barrier in the event of a mini-fuel-rod failure
- Control the thermal resistances in the heat-flux path from the fuel to the coolant so that the desired fuel temperature can be reached
- Provide the means for instrumentation wires to reach outside the reactor core
- Enable gas sampling above the plenum region of the capsule above the mini-fuel-rod in order to detect fuel failure.

The capsules were designed and constructed so that the fuel-centerline and cladding-outer diameter (OD) temperatures for each capsule could be monitored by thermocouples throughout the experiment.

Accomplishments

Irradiation began on a two-capsule fuel rod assembly inserted into the lower and middle positions of the fuels channel on March 28, 2011. The capsule in the middle position received a slightly higher flux and temperature due to its location near the midpoint of the reactor core length. The upper position was filled with

Distributed Partnership at a Glance

ATR NSUF & Partners—Facilities & Capabilities

Massachusetts Institute of Technology—Research reactor

Idaho National Laboratory—PIE facilities

Team Members/Collaborators

University of California, Berkeley

Donald R. Olander, Mehdi Balooch (principal investigators)

Oak Ridge National Laboratory

Kurt Terrani (collaborator)

Massachusetts Institute of Technology

Tom Newton, Gordon Kohse, Lin-Wen Hu, (collaborators), David Carpenter (post-doctoral student)

Idaho National Laboratory

Mitch Meyer, Jim Cole (principal investigators), Joy Rempe (collaborator)

“This hydride fuel irradiation experiment was the first fueled test conducted under ATR NSUF that successfully demonstrated fuel irradiation under engineered LWR conditions with in-pile instrumentation inside the MIT nuclear reactor.”

Kurt Terrani, Collaborator, Oak Ridge National Laboratory

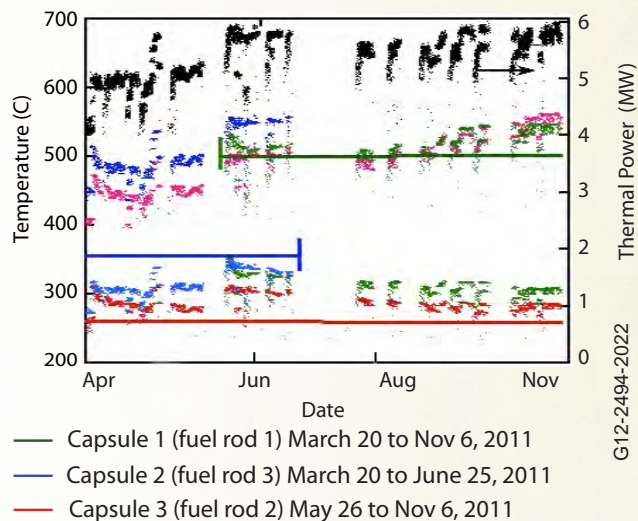

Figure 2. Center fuel rod and cladding temperature of fuel rods 1, 2 and 3 along with thermal power history.

a dummy aluminum capsule. A third capsule assembly, also containing a fuel rod, was inserted on May 26, 2011. The reactor power was gradually increased to 4.9 megawatts (MW) at the start, and has been raised as high as 6.0 MW during the course of irradiation.

Neutron detectors near the core monitored neutron powers and produced readings consistent with thermal powers calculated from temperature gradients and water flow rates through the core. K-Type thermocouples monitored the center fuel pellet and cladding temperatures continuously throughout the irradiation and during core shutdowns.

The helium cover gas inside the titanium fuel capsules has been periodically purged into a sampling container and analyzed for excessive fission gas release from the fuel elements. On June 26, 2011, an increase was noted in the middle capsule and it was removed because of a suspected gasket leak. The leak was believed to have been caused by the numerous shutdowns and re-starts that have occurred for various reasons since the start of irradiation. The capsule was kept in the core tank’s wet storage ring until it could be removed to the spent fuel pool.

Figure 2 shows the center fuel and cladding temperatures, along with the thermal power history of the three fuel rods currently under irradiation. Only data with thermal power greater than 4 MW are shown. As of November 6, 2011, the lower capsule, with fuel rod #1 had been irradiated the longest.

The calculated changes in thermal conductivities of the three irradiated rods are shown in Figure 3. Note that there is a temperature gradient across the radius of the fuel and that the values given are radial averages. The initial values were adjusted at the beginning of irradiation in order to be

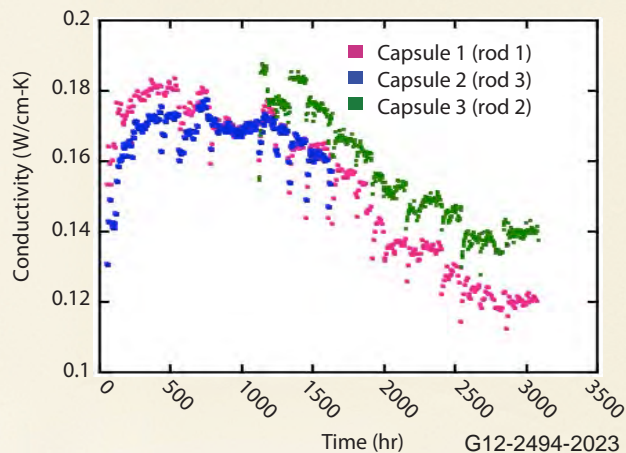

Figure 3. Thermal conductivity variation with irradiation exposure for thermal power greater than 4 MW.

as close as possible to the known value of 0.17 W/cm-K as reported in the literature for room temperature¹. The absolute values will be determined later by correlating thermal and neutron powers with linear heat rate using detailed Monte Carlo N-Particle (MCNP) Transport Code calculations. However, the decrease in thermal conductivity with exposure after initial variation is evident for all three rods.

Future Activities

The last two hydride mini-fuel rods are scheduled for insertion into the MITR in early 2012. One will be monitored with a thermal conductivity probe developed by INL, the other with a helium gas-filled gap. The probe is expected to provide thermal conductivity independent of the conventional method used in the first phase of the project, which relies on determining the temperature gradient between the fuel centerline and the cladding outer surface.

Once the fuel rods cool to levels that allow for transport, they will be shipped to INL’s Hot Fuel Examination Facility (HFEF), where the extent of fission-gas release from the fuel through the LM gap filler will be examined and fuel swelling will be measured to determine whether it is due to solid fission products, fission-gas bubbles, or other defects. Redistribution of hydrogen in the fuel and the condition of the Zircaloy cladding will also be investigated. Activities will involve transmission and scanning electron microscopy, X-ray diffraction and mass spectroscopy, along with other techniques to characterize the endstate of the hydride fuel.

Reference

[1] K. Terrani, J. Seifried, D. Olander, “Transient Hydride Fuel Behavior in LWR’s,” *Journal of Nuclear Materials*, 392, (2009) 192.

Radiation Stability and Integrity of Amorphous Metal Alloys for Applications in Harsh Environments

Principal Investigator: Lin Shao – Texas A & M University
(e-mail: lshao@ne.tamu.edu)

Introduction

Due to their attractive physical and chemical properties such as high strength and high corrosion resistance, metallic glasses are viewed as a potential new class of structural materials for harsh environments. However, their technical application has been limited by their poor ductility. This problem can be resolved through the formation of nanocrystals in the glassy alloy. What is more, the formation of a nanocomposite structure can further improve the mechanical and functional properties of these alloys.

The highly scientific work of this project provides significant insight into the fundamental performance of metallic glasses. The research method applied is unique from any other methods yet used.

Project Description

This ATR NSUF project was a collaboration between Texas A&M University and Tohoku University as follows: the transmission electron microscope (TEM) specimen was prepared using a focused ion beam (FIB) in the Center for Advanced Energy Studies Microscopy and Characterization Suite at INL; Texas A&M University performed the ion irradiation; and Tohoku University, fabricated the metallic glass.

The goal of this project is to develop a nanostructured, superior strength alloy by inducing nanocrystallization in metallic glass, a material in which nanoscale structures are difficult to form. Project researchers are studying the mechanism through which ion irradiation creates nanocrystallization, as well as the impact nanocrystallization has on the mechanical properties of metallic glasses.

Distributed Partnership at a Glance

ATR NSUF & Partners—Facilities & Capabilities

Center for Advanced Energy Studies—Microscopy & Characterization Suite

Team Members/Collaborators

Texas A&M University

Lin Shao (principal investigator), Assel Aitkaliyeva (Ph.D. student), Guogiang Xie (collaborator)

Idaho National Laboratory

Bulent H. Sencer (principal investigator)

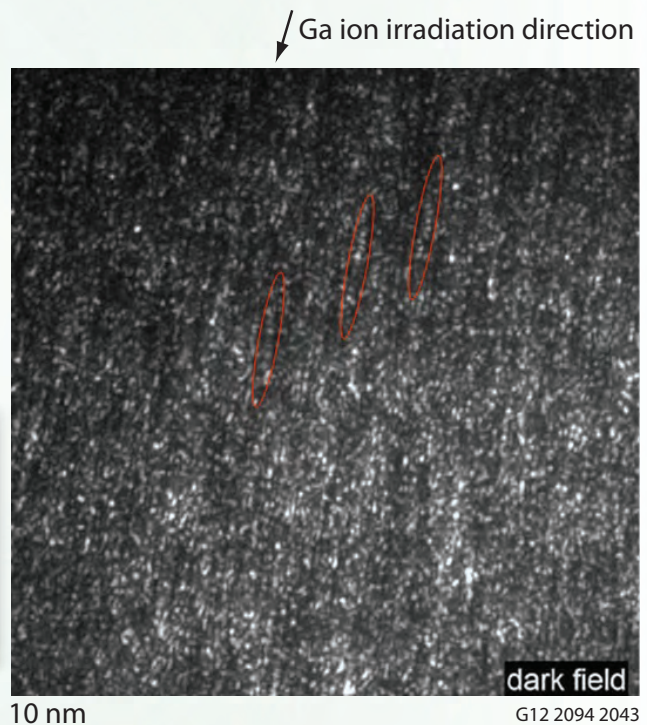

Figure 1. Dark-field TEM image of $\text{Cu}_{50}\text{Zr}_{45}\text{Ti}_5$ metallic glass specimen showing chained nanocrystals. This finding suggests that damage cascades can convert the metallic glass into nanometer-sized crystals.

Accomplishments

The project team has studied nanocrystal formation in ion-irradiated metallic glass ($\text{Cu}_{50}\text{Zr}_{45}\text{Ti}_5$). The metallic glass was prepared by melting mixtures of pure copper (Cu), zirconium (Zr), and tin (Ti) in an argon atmosphere. INL's FIB—generating 30-keV gallium (Ga) ions—was used to prepare a specimen for examination through a TEM. The resulting TEM image (Figure 1) shows the formation of nanocrystals in the specimen. The nanocrystals are aligned with the Ga ion bombardment direction, which suggests that nanocrystal formation is caused by damage cascade formation along the trajectories of incident Ga ions.

Researchers have also explored the radiation effects of helium (He) ions on metallic glasses. Nanoindentation tests and high-resolution TEM were used to characterize the irradiated samples. Significant hardness changes were observed in a region that had both nanocrystals and gas bubbles. Researchers have found that implanted He gas atoms induce void formation. Surprisingly,

“The user facility at the Idaho National Laboratory is critical to the success of the project. Our first-year findings strongly suggested the high impact of the project.”

Lin Shao, Assistant Professor of Nuclear Engineering, Texas A&M University

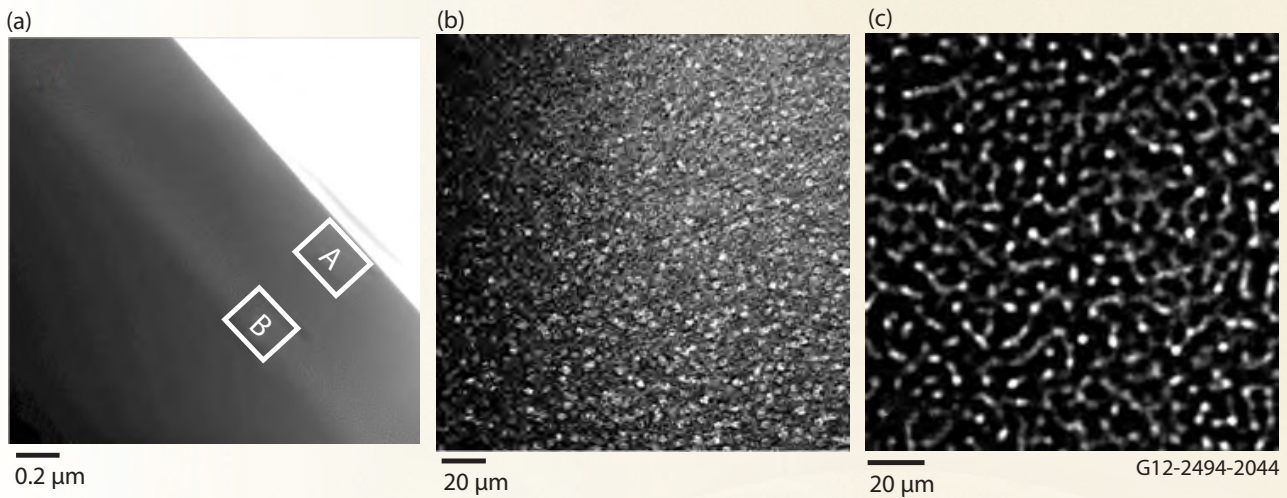

Figure 2. (a) Bright-field cross-section TEM micrograph of $\text{Cu}_{50}\text{Zr}_{45}\text{Ti}_5$ metallic glass irradiated with He ions. A = near-surface region, and B = He peak region. A band-like structure appears at a depth of 600 nanometers (nm). (b) Bright-field TEM of A showing He-induced, 2 – 5 nm spherical voids. (c) Bright-field TEM of B, a highly porous area characterized by 2 – 4 nm, randomly oriented, tunnel-like structures.

these nanometer-size voids connect to each other to form tunnels in the metallic glass (Figure 2).

Given these results, researchers expect the project to impact fundamental understandings in two materials science subfields:

- (1) **Ion solid interaction.** Phase transition from amorphous to crystalline in metallic materials is barely understood. This project will improve our fundamental understanding of the structural effects under different time scales of damage cascade creation, thermal spike formation, and structural relaxation evolution.
- (2) **Direct crystallization.** Researchers expect chain-like nanocrystals to form along the ion track (Figure 3). This might involve a surface modification method

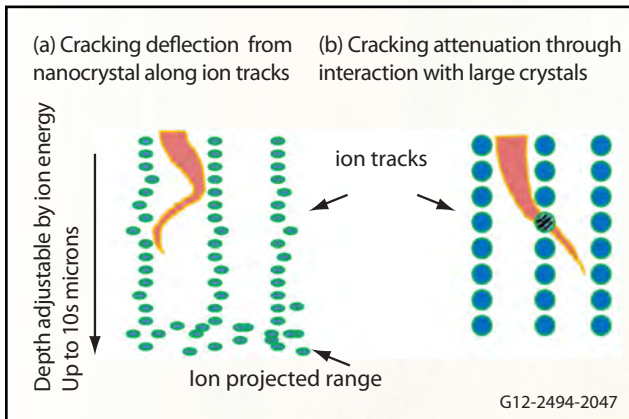

Figure 3. Schematics of shear band interaction with chain-like crystals of different sizes, formed by ion irradiation. These interactions are expected to enhance the materials' ductility.

to improve ductility in the metallic glass. Due to the nature of ion-solid interactions, the chain-like crystal distribution will diminish at the end of the projected range, and the “channel” will be sealed by randomly distributed crystals. Therefore, the shear bands are expected to be confined both vertically and horizontally.

Furthermore, depending on the mechanical strength and details of the crystal-matrix interfaces, the system is expected to have an enhanced stress tolerance, which will delay shear-band initialization. Although the expected improvement in the material's mechanical properties will occur only in the near-surface region and will be limited by the ion penetration depth, it will improve the bulk behaviors of the material, since most catastrophic failures are likely to occur at the surface.

Future Activities

The researchers plan to submit new proposals to continue the research using cluster ion bombardment in order to control nanocrystal formation.

University of Wisconsin Pilot Project at the Advanced Test Reactor National Scientific User Facility

Introduction

This project involves neutron irradiations and associated post-irradiation examination (PIE) of a wide range of structural materials that relate directly to present and future nuclear energy systems.

PIE materials are being characterized using transmission electron microscopy (TEM), small-angle neutron scattering (SANS), and atomic probe tomography (APT). Mechanical properties of irradiated materials will be evaluated using microhardness, shear punch and tensile testing.

Irradiation samples were provided by the University of Michigan (UM), Los Alamos National Laboratory (LANL), the University of Wisconsin (UW), Pennsylvania State University (PSU), Westinghouse Electric Company, Alabama A & M University, Oak Ridge National Laboratory (ORNL), and the Japan Atomic Energy Agency (JAEA).

Samples of various geometries were prepared and documented at UW and loaded into irradiation capsules at the ATR NSUF in June 2008. During 2010, the first samples were irradiated at 500°C to a dose of 3 displacements per atom (dpa) and shipped to various U.S. facilities for characterization.

A comparison of the oxide distribution before and after high-dose irradiation provided key information on the stability of these microstructures.

Project Description

The project is an ambitious effort to irradiate more than 500 individual samples of a wide range of materials, including:

- Ferritic steels T91, NF616 and HCM12A
- 9%Cr oxide dispersion strengthened (ODS) steels
- Fe-9%Cr and Fe-12%Cr binary compositions (*to get more fundamental insights into the radiation response of ferritic steels*)
- Austenitic steels and alloys, such as IN800H, D9 and NF709
- Advanced concept alloys developed at ORNL, including super 304 stainless steel and HT-UPS-AX-6

- Grain-boundary-engineered HCM12A and IN800H (*to understand the effects of grain boundary character distribution in mitigating radiation damage*)
- Ceramics ZrO₂-MgO and silicon carbide (SiC)
- Pure metals tungsten (W) and silver (Ag) (supplied by Westinghouse)
- Mo-ODS.

Irradiations were performed at 300°C, 400°C, 500°C, and 700°C to doses of 3 dpa and 6 dpa. These temperatures were established through thermal modeling, by adjusting the gas-gap distance and, experimentally, by placing SiC electrical resistivity samples in select capsules. Samples consist of 3mm-diameter TEM disks, miniature 16mm tensile samples and SiC rods.

Researchers used an array of PIE techniques, including high-resolution transmission electron microscopy (HR-TEM), APT, SANS, microhardness testing, shear punch testing, and tensile testing. The PIE work is being performed at the Hot Fuel Examination Facility (HFEF) and Electron Microscopy Laboratory (EML) at INL; Center for Advanced Energy Studies (CAES) in Idaho Falls, Idaho; HR-TEM facility at the University of Nevada, Las Vegas (UNLV); ORNL; SANS facilities at the National Institutes of Standards and Technology (NIST); Los Alamos Neutron Science Center (LANSCE) at LANL; and the Characterization Laboratory for Irradiated Materials (CLIM) at UW.

Accomplishments

Sample irradiations began in September 2008, with a majority of the 3-dpa samples being irradiated in July 2010. The remaining 3-dpa samples were loaded when the first 3-dpa samples were removed, and all project irradiations will be completed by May 2012. PIE on the first 3-dpa samples is in progress.

Samples of 9%Cr ODS steel were neutron-irradiated at 500°C to a level of 3 dpa and shipped to CAES, where samples were prepared for APT using a focused ion beam (FIB). Atom-probe samples were prepared and then characterized at CAES using a local electrode atom probe (LEAP). As shown in Figures 1 and 2, the oxide nanoclusters, which are critical to the high-temperature strength of this steel, were stable under irradiation test conditions.

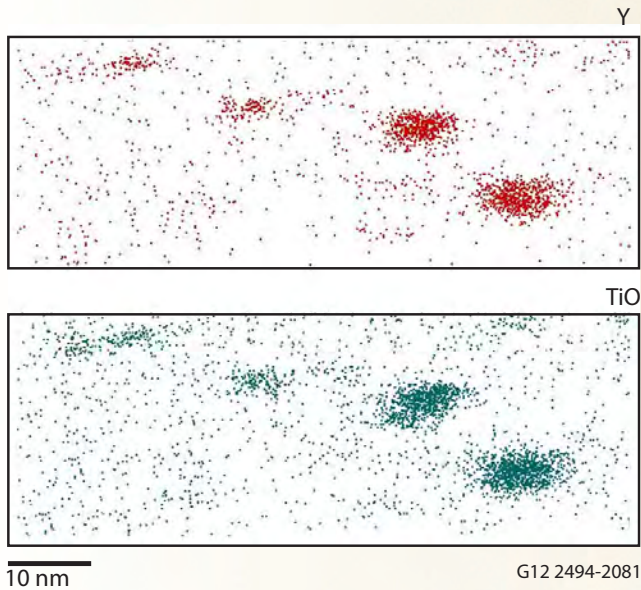

Figure 1. APT atom maps of the as-received (unirradiated) 9%CrODS showing nanoclusters of (Y, Ti) oxide.

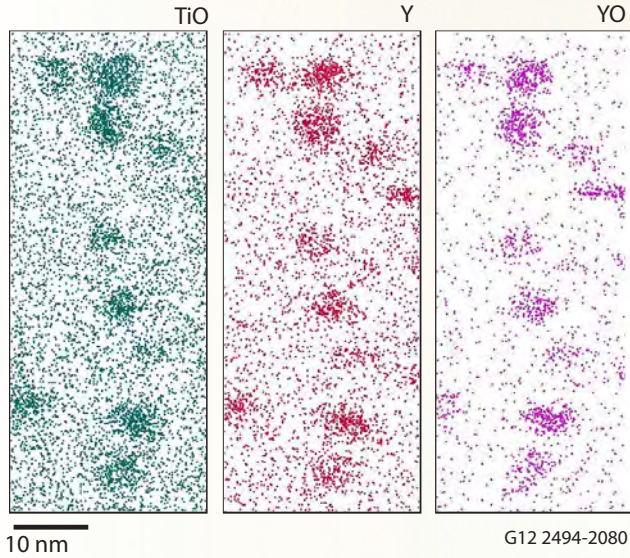

Figure 2. APT atom maps of the 9%Cr ODS sample neutron-irradiated to 3 dpa at 500°C, indicating the stability of (Y, Ti) oxide nanoclusters after irradiation. Samples of 9%Cr commercial ferritic steel NF616 irradiated at the ATR NSUF at 500°C to a level of 3 dpa were characterized using scanning transmission electron microscopy (STEM) and APT.

The partner facilities are being utilized to maximum effect. Neutron-irradiated IN 800H in the as-received and grain-boundary-engineered samples have been shipped to ORNL, where evaluation has begun. The LANSCE facility is being used extensively, particularly for evaluating the irradiation response of grain-boundary-engineered alloys. UW researchers have also performed SANS work at LANSCE. Preparations for mechanical testing of irradiated samples are underway at HFEF.

In support of the ATR NSUF project, researchers are also conducting proton irradiation studies and characterizing the samples to make structural comparisons between the effects of neutron and proton irradiations. 9%Cr model ferritic/martensitic steel was irradiated to 1 dpa, 2 dpa, and 3 dpa at 400° C at the UW Ion Beam Laboratory (IBL) using protons. PIE was then completed at CAES.

Focused ion beam (FIB) lift-outs were fabricated for TEM at CAES. Subsequently, researchers at CAES used STEM-EDS to examine as-received FIB lift outs for variations in the chromium distribution at the lath boundaries of the steel sample. Examples of elemental maps, including the annular dark-field contrast image for an Fe-9%Cr sample, are provided in Figure 3.

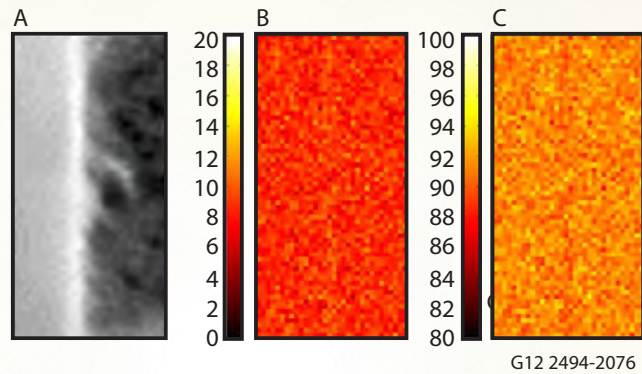

Figure 3. Annular dark-field image of lath boundary in as-received model steel, B) weight percent chromium map (bulk concentration: ~8.68% Cr), C) weight percent iron map.

University of Wisconsin Pilot Project at the Advanced Test Reactor National Scientific User Facility (cont.)

The work on proton-irradiated samples has provided students with valuable hands-on experience with advanced characterization methods that are directly applicable to the analysis of neutron-irradiated samples from this ATR NSUF pilot project. Furthermore, any correlations between structural changes in the neutron and proton irradiations would be an important step in the advancement of nuclear materials research.

Future Activities

Future project work will focus on detailed characterization of the samples irradiated at 500°C to a level of 3 dpa. Specific irradiated materials selected for in-depth analysis include 9%Cr ODS steel, Fe-9%Cr model alloy, Fe-12%Cr model alloy, NF616 and T91 steels, and HCM12A and IN800H (both as-received and grain-boundary engineered).

Analysis of the small-angle neutron scattering data on both the as-received and neutron-irradiated NF616 and HCM12A will continue through 2012. The analysis is expected to resolve changes observed in the precipitate size and void formation that result from irradiation. Initial work will also begin on using the SANS technique to probe the texture of the alloys. Results from the SANS experiments will then be merged with results from other analysis techniques to develop a fundamental understanding of the radiation damage processes that occur in ferritic/martensitic steels. The researchers plan to involve students and professionals from a number of other universities in this PIE work. Mechanical testing of neutron-irradiated samples (and their as-received counterparts) will begin at the MFC facility at INL. Testing methods will include microhardness, shear punch and tensile testing.

During 2012, the remaining 3-dpa and all of the 6-dpa samples will come out of the ATR. Planning and PIE experiments on these samples will also begin in the coming year.

Publications and Presentations

1. K. Sridharan, T.R. Allen, Y. Yang, P. Xu, L. Tan, T. Gerczak, H. MacLean, and J. Foster, "ATR-NSUF Pilot Project: Irradiation of Reactor Structural Materials," FCRD Advanced Materials Development Working Group Meeting, Santa Barbara, CA, 2010.
2. J.L. Rempe, K.G. Condie, D.I. Knudson, and L.I. Snead, "Comparison of Silicon Carbide Temperature Monitors." IEEE, TNS-00048, 2010.
3. J.L. Rempe, K.G. Condie, and D.L. Knudson, "Silicon Carbide Temperature Evaluation Monitors," INL-PLN-3473, 2010.
4. H. Chichester, K. Sridharan, R. Prabhakaran, Y. Yong, P. Xu, and T. Allen, "Program for Irradiation of Reactor Structural Materials at ATR National Scientific User Facility"; proc. The Metallurgical Society Annual Conference, San Diego, CA, February 2011.
5. K.G. Field, L.M. Barnard, C.M. Parish, J. T. Busby, D.D. Morgan, T.R. Allen. "Role of Grain Boundary Structure on Radiation Induced Segregation in a Model Ferritic/Martensitic Steel." Abstract submitted to Materials Research Society Spring Conference 2012.

Distributed Partnership at a Glance
ATR NSUF & Partners—Facilities & Capabilities
Idaho National Laboratory —Advanced Test Reactor, PIE facilities
Team Members/Collaborators
<p>University of Wisconsin Kumar Sridharan (principal investigator), Yong Yang (collaborator, presently at the University of Florida), Peng Xu (presently at Westinghouse), Yina Huang, Kevin Field, Alicia Certain, Tyler Gerczak (Ph.D. students), Spencer Morris, Thomas Eiden (undergraduate students)</p> <p>Idaho National Laboratory Heather Chichester (co-principal investigator), Ram Prabhakaran (Ph.D. student), Mitch Meyer, Joy Rempe, James Cole (collaborators)</p> <p>University of Michigan Gary Was, George Jiao (collaborators)</p> <p>Pennsylvania State University Arthur Motta (collaborator)</p> <p>University of Nevada, Las Vegas Longzhou Ma (collaborator)</p> <p>Alabama A & M University Claudiu Montele (collaborator)</p> <p>Oak Ridge National Laboratory Jeremy Busby, Lizhen Tan (collaborators)</p> <p>Los Alamos National Laboratory Maria Braga (collaborator, presently at the University of Portugal), Rex Hjelm (collaborator)</p> <p>Japan Atomic Energy Agency Shigeharu Ukai (collaborator, presently at Hokkaido University)</p> <p>National Institutes of Standards and Technology John Barker (collaborator)</p>

Irradiation Performance of Iron-Chromium (Fe-Cr) Base Alloys

Ferritic alloys have emerged as a potentially excellent alternative in the construction of advanced nuclear power systems.

Introduction

As we reported last year, the emergence of ferritic alloys as a potentially excellent alternative in the construction of advanced nuclear power systems has spurred an investigation into how well they stand up to high levels of radiation under near-real-world conditions. In preliminary studies, ferritic alloys have proven superior to established materials like austenitic stainless steel in the following areas:

- Resistance to void swelling
- Thermal conductivity
- Thermal expansion
- Mechanical strength at high temperatures.

Of the many ferritic alloys studied, iron-chromium (Fe-Cr) has emerged as the leading candidate material for several advanced reactor components and applications.

Project Description

The primary objective of the project is to gain a new level of understanding into how Fe-Cr alloys perform under the various radiation conditions they will be subjected to in an actual commercial application. The project team, consisting of researchers from no fewer than five institutions, is performing a set of experiments that subjects selected Fe-Cr model, commercial, and developmental alloys to a series of common irradiation scenarios. Data collected through subsequent post-irradiation examination (PIE) and analysis will guide future development of materials for advanced reactors by helping engineers predict the future radiation performance of the entire Fe-Cr alloy family.

Table 1. Test Matrix (12 materials, 3 irradiation temperatures, 6 doses).

Alloy	Temperature	Dose (dpa)	Specimen Types
Model Alloy: Fe, Fe-9Cr, Fe-9Cr-0.1C, Fe-9Cr-0.5C, Fe-12Cr, Fe-12Cr-0.2C, Fe-12Cr-0.5C, Fe-14Cr*, Fe-19Cr*	300, 450, 550	0.01, 0.1, 0.5, 1.0, 5.0, 10	TEM, Miniature tensile
Commercial Alloys: T91, HT-9	300, 450, 550	0.01, 0.1, 0.5, 1.0, 5.0	TEM Miniature tensile
Developmental Alloys: MA-956	300, 450, 550	0.01, 0.1, 0.5, 1.0, 5.0	TEM Miniature tensile

* Single crystal materials, no miniature tensile specimens.

The project team is focusing its research on two sample geometries:

1. Samples that undergo transmission electron microscope analysis
2. Samples for measuring tensile strength.

Placed in two different positions in the ATR, the samples were subjected to irradiation temperatures of 300, 450 and 550°C (Table 1).

Irradiations with low target doses of 0.01 and 0.1 displacements per atom (dpa) are performed in the ATR's hydraulic shuttle system or "rabbit." Materials receiving high-dose irradiations (0.5 dpa – 10 dpa) occupy the A-11 position.

Accomplishments:

All high-dose capsules (0.5 dpa – 10 dpa) have been inserted, and those capsules that have completed irradiation have been transferred to the Hot Fuel Examination Facility (HFEF) for unloading. The irradiation cycles for these capsules are shown in Table 2.

Titanium capsules containing materials machined at the University of Illinois for low-dose irradiations (0.01 dpa and 0.1 dpa) were inspected, tested, and loaded at position B-7 (hydraulic shuttle irradiation system 'HSIS') in June 2011. Approximate exposure periods were one day and ten days. Upon completion of the irradiation, the capsules were removed and, to the investigators' best knowledge, have been transferred to the HFEF for PIE in early 2012.

Future Activities

High-purity Fe and Fe-Cr alloys constitute the research team's highest priority for transmission electron microscopy (TEM) examination. Post-irradiation experiments and preparation of TEM samples are expected to begin the first quarter of 2012, although the actual start dates depend upon the availability of facilities and personnel at INL. Currently, ATR NSUF funding will allow for the examination of only a

“The ATR experimental facility is the first real opportunity for university programs to plan and lead reactor irradiation experiments in the US. This adds a whole new dimension to the understanding of radiation effects in reactor materials and provides the training ground for students who will become the next generation of researchers in this area.”

J.F. Stubbins, Professor and Department Head, Nuclear, Plasma and Radiological Engineering, University of Illinois

Table 2. Irradiation Cycle and Capsule Arrangement at position A-11.

Cycle	145A	145B	146A	146B	147A	147B	148A	148B
Cycle Time								
(EFPD)	56	49	56	49	49	14	56	49
Distance from Core mid-plane (inch)								
20.375		UI-0.5-300A		UI-0.5-450A	UI-0.5-550A			
13.875		UI-1.0-300A		UI-1.0-450A	UI-1.0-550A			
5.500	UI-5.0-450	UI-5.0-450	UI-5.0-450					
2.500	UI-10-450	UI-10-450	UI-10-450	UI-10-450	UI-10-450		UI-10-450	UI-10-450
-0.500	UI-10-550	UI-10-550	UI-10-550	UI-10-550	UI-10-550		UI-10-550	UI-10-550
-3.500	UI-10-300	UI-10-300	UI-10-300	UI-10-300	UI-10-300		UI-10-300	UI-10-300
-6.500	UI-5.0-300	UI-5.0-300	UI-5.0-300	UI-5.0-550	UI-5.0-550		UI-5.0-550	
-15.875		UI-1.0-300B		UI-1.0-450B	UI-1.0-550B			
-22.625		UI-0.5-300B		UI-0.5-450B	UI-0.5-550B			

small fraction of the irradiated specimens that are currently at HFEF. Because of these funding limitations the TEM investigations may be limited, at least initially to a few lower-dose exposures on the high-purity materials.

The research team, therefore, is exploring ways to transfer the tensile specimens to alternate locations for testing. The team may also undertake similar efforts for the TEM disk specimens so those proposed experiments having interconnections with other studies can be carried forward. They are also exploring other venues for these experiments so the full complement of planned experiments can remain intact.

Publications and Presentations

1. C.S. Deo, S. G. Srinivasan, M.I. Baskes, S. A. Maloy, M.R. James, M. Okuniewski, and J. Stubbins, “Kinetics of the Migration and Clustering of Extrinsic Gas in bcc Metals,” ASTM Special Technical Publication, 1492, pp. 177-189 (Nov. 2008).
2. X. Pan, X. Wu, X. Chen, K. Mo, J. Almer, D.R. Haeffner; and J. F. Stubbins, “Temperature and particle size effects on flow localization of 9-12%Cr ferritic/martensitic steel by in situ X-ray diffraction and small angle scattering,” *Journal of Nuclear Materials*, 398 (1-3) 220-226 (2010).
3. X. Pan, X. Wu, X. Chen, K. Mo, J. Almer, J. Ilavsky, D.R. Haeffner, and J. F. Stubbins, “Lattice strain and damage evolution of 9-12%Cr ferritic/martensitic steel during in situ tensile test by X-ray diffraction and small angle scattering,” *Journal of Nuclear Materials*, 407(1) 10-15 (2010).
4. Carolyn Tomchik, Jian Gan, James Stubbins, Mark Kirk, “Low Dose Neutron Irradiations of Iron and Iron-chromium Model Alloys in the ATR-NSUF,” presented at the 15th International Conference on Fusion Reactor Materials, Charleston, SC, October, 2011.

Distributed Partnership at a Glance
ATR NSUF & Partners—Facilities & Capabilities
Idaho National Laboratory —Advanced Test Reactor, PIE facilities
Team Members/Collaborators
University of Illinois James Stubbins (principal investigator), Carolyn Tomchik (Ph. D. Student)
Idaho National Laboratory Jian Gan (principal investigator), Maria Okuniewski (co-investigator)
Georgia Institute of Technology Chaitanya Deo (collaborator)
General Electric Company Eric Loewen (collaborator)
Los Alamos National Laboratory Stuart Maloy (collaborator)

Microstructural and Irradiation Effects on Silver (Ag) and Cesium (Cs) Diffusion in CVD-Silicon-Carbide (SiC)

Tristructural-Isotropic (TRISO) fuel is the proposed fuel of choice for the high-temperature gas-cooled reactor. TRISO fuel is a spherical particle fuel and is comprised of a uranium-oxide/uranium-carbide kernel, surrounded by a porous carbon buffer layer, an inner pyrocarbon layer, a silicon carbide (SiC) layer, and an outer pyrocarbon layer. The ceramic/graphite construction of TRISO fuel is a primary factor in allowing reactors to operate at high temperatures, which, in turn, increases the efficiency and utility of gas-cooled reactor design.

The ceramic/graphite construction also promotes enhanced reactor safety by reducing the threat of a core meltdown caused by insufficient cooling. In TRISO fuel, the SiC layer serves as the main metallic fission-product barrier; however, the release of Ag and Cs from seemingly intact particles has been observed, causing concerns about maintenance, safety and limitations on fuel lifetimes. To ensure safe and effective reactor operation, an understanding of the mechanism and kinetics behind the release must be understood.

Project Description

The goal of this project is to gain a complete understanding of:

- Ag and Cs transport in irradiated and unirradiated SiC
- The kinetics of bulk diffusion
- The roles of short-circuit diffusion pathways in individual grain boundaries.

It is hoped that understanding the contributions of multiple diffusion pathways will lead to an engineering solution for mitigating the release of fission products from the TRISO fuel during reactor operation, thus improving safety and increasing fuel lifetime.

This project will advance the basic knowledge of fission-product behavior in TRISO fuel.

It has been hypothesized that the fission-product release is caused by the diffusion of Ag and Cs through the SiC layer. Therefore, ion implantation diffusion couples are being investigated to confirm the mechanisms of active diffusion and to measure diffusion kinetics. Researchers have selected three SiC substrates for investigation:

- Commercial polycrystalline CVD-SiC from Rohm and Haas
- Polycrystalline fluidized bed CVD-SiC from the Oak Ridge National Laboratory (ORNL)
- Single-crystal SiC from Cree, Inc.

The polycrystalline SiC substrates simulate Ag and Cs diffusion in TRISO fuel and allow researchers to investigate grain-boundary, short-circuit diffusion in SiC. The single-crystal sample allows researchers to isolate the mechanics of lattice diffusion. Diffusion kinetics can be determined by observing ion implantation diffusion couples, since the Gaussian implantation peak serves as a constant source approximation (Figure 1).

Secondary ion mass spectroscopy (SIMS) is used to measure the change in Ag and Cs concentrations following thermal exposure. For selected samples, atom probe tomography (APT) is used to investigate the role of specific grain boundaries on short-circuit diffusion. APT reveals variations in the segregation of the diffusing impurity species past the implantation zone.

Additionally, the effect of irradiation on Ag and Cs diffusion is investigated by measuring the elements' diffusion in proton-irradiated SiC substrates. Enhanced short circuit diffusion is possible in irradiated substrates due to the interaction of non-equilibrium point defects with grain boundaries and through the evolution of microstructural defects.

Accomplishments:

To date, all substrates—the single-crystal SiC from Cree, Inc., the CVD-SiC from Rohm and Haas, and the CVD-SiC from ORNL—have been ion implanted at the University of Michigan Ion Beam Laboratory, which is a partner facility of ATR NSUF.

Distributed Partnership at a Glance
ATR NSUF & Partners—Facilities & Capabilities
University of Michigan —Ion Beam Laboratory
Team Members/Collaborators
University of Wisconsin Izbabela Szlufarska (principal investigator), Tyler Gerczak (graduate student)
Idaho National Laboratory Jim Cole (co-principal investigator)
Michigan Ion Beam Laboratory Ovidiu Toader (collaborator)
Pacific Northwest National Laboratory Zihua Zhu (collaborator)

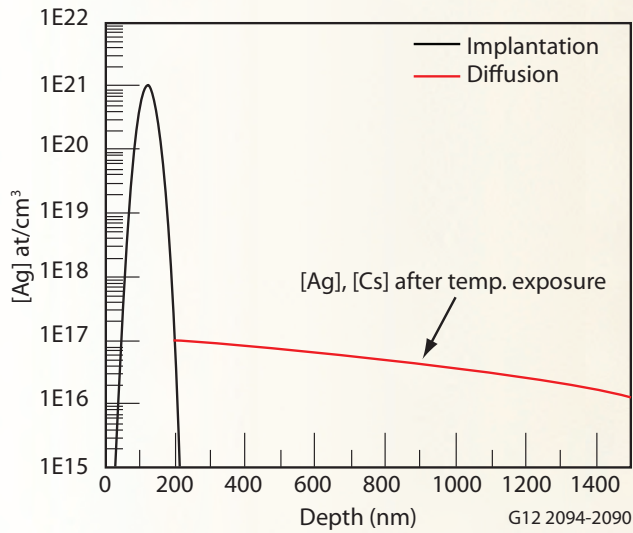

Figure 1. Schematic of ion implantation diffusion couple.

The samples were implanted separately with Ag^+ and Cs^+ at 400 kV to doses of 1×10^{14} – $2 \times 10^{16} \text{ cm}^{-2}$ at 300 – 350°C. Initial temperature exposures of 1200 – 1700°C have been completed, and a SIMS analysis has been conducted on the preliminary samples. Initial results suggest impurity diffusion is active in the Ag/SiC system, as researchers observed an arm of the Ag concentration extending into the bulk SiC past the implantation peak at 1500°C (Figure 2).

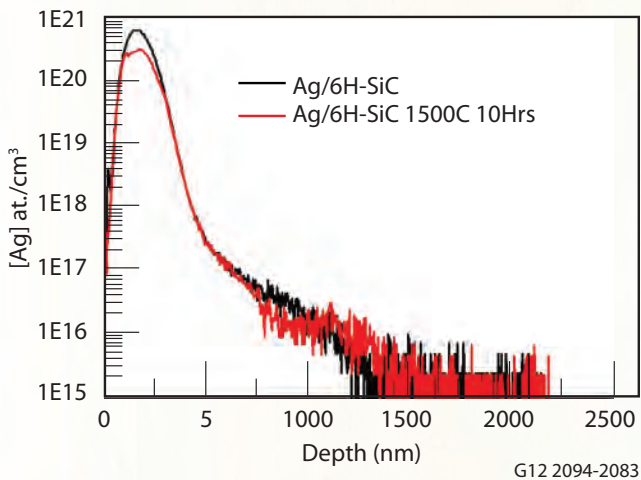

Figure 2. SIMS depth profiles of Ag in 6H-SiC, as implanted at 1500°C under 10 hours of exposure.

Future Activities

With the promising results observed in the initial exposures, researchers are excited to investigate additional exposure conditions at additional temperatures and times to completely understand the thermal dependence and kinetics of Ag and Cs diffusion in SiC.

The contribution of microstructural features to Ag and Cs transport will also be investigated. This effort will use APT to spatially resolve the segregation of the diffusing species in microstructural features of the SiC substrate. Researchers will also gain an understanding of the effect of irradiation on diffusion by repeating the diffusion couple experiments using irradiated substrates.

Publications and Presentations

1. T. Gerczak, T. Allen, and Z. Zhu, “Cesium and Silver Diffusion in SiC for TRISO Applications,” *Transactions of the American Nuclear Society*, Hollywood, Florida, June 26 – 30, 2011, 47-48.

Corrosion Test in Supercritical Water for Nitride-based Coatings on Light Water Reactor Cladding

Introduction

The supercritical water test is essential for demonstrating the corrosion resistance properties of fuel cladding rods under high-temperature water conditions. It is also important in the selection of nitride-based coating candidates for future implementation in light water reactors (LWR).

This ATR NSUF collaborative effort between Dr. Haiyan Wang at Texas A&M University (TAMU) and Drs. Hongbin Zhang and Jian Gan at the INL, complements the Office of Nuclear Energy's goal of developing advanced LWRs. The newly developed coatings have shown great possibilities in preventing corrosion and crud buildup, thereby significantly extending the lifetime of cladding tubes in LWRs.

Project Description

Various nitride coatings were applied to the outer surface of Zircaloy cladding tubes as a corrosion resistance layer and tested at TAMU using both transmission electron microscopy (TEM) and Scanning Electron Microscopy (SEM). Since supercritical water conditions are not currently available at TAMU, the samples were then transported to the University of Michigan for further testing. A two-day supercritical water test and a subsequent five-day high temperature water test of fuel claddings, with and without coatings was conducted in 2011. Results clearly demonstrated the effectiveness of the corrosion resistance coatings against both supercritical and high temperature water. The tests provided very important feedback on the future selection and implementation of coating candidates for Zircaloy cladding tubes in LWRs.

Accomplishments

Thin film deposits of six different types of coatings were applied to polished Zircaloy tubes and tested under supercritical water (500°C) for two days. The results were both surprising and exciting. Figure 1 shows the coated sample coupons compared with uncoated, bare substrate coupons. The coated samples all show a very shiny

and smooth surface with good surface uniformity. The titanium-nitride (TiN) based coatings can be distinguished by their golden color.



G12-2494-2038

Figure 1. Polished cladding tubes without coating (left) and cladding tubes with TiN coating on the front and back (right).

After the two-day test, the bare substrate samples clearly exhibited severe corrosion, as seen in Figure 2. The surface of the bare tube varied significantly, and its shape also changed drastically. However, the tube with the TiN coating on the surface showed no obvious shape changes and the tube remained intact. The coating on the surface suffered no delamination or cracking, although the surface color is slightly changed.



G12-2494-2041

Figure 2. The bare tube (left) after two days in supercritical water at 500°C. The tube exhibited severe corrosion and swelling, and the original shape had changed. The cladding tube with TiN coating (right) showed no change in shape after the two day test. The surface color had changed slightly, but there was no obvious degradation to the tube itself. These results clearly demonstrate the effectiveness of the coatings.

This ATR NSUF project allows us to test our research hypothesis and build the foundation for future work on the coating effort.”

Haiyan Wang, Associate Professor and Department Head, Electrical Engineering, Texas A&M University

“The results were both surprising and exciting.”

Future Activities

Pending funding, more tests are planned for 2012. In addition, plans are underway to expand the project by exploring other candidate coating materials having different grain sizes and compositions. This study will lay a solid foundation for the ongoing exploration of tube coating on fuel cladding tubes.

Publications

1. Ickchan Kim, Fauzia Khatkatay, Liang Jiao, Greg Swagnager, James Cole, Jian Gan and Haiyan Wang, “TiN-Based Coatings on Fuel Cladding Tubes for Advanced Nuclear Reactors,” *Journal of Nuclear Materials*, accepted..

Patents

Haiyan Wang, Jian Gan, Hongbin Zhang, “Nitride-based Coatings for Fuel Cladding Tubes,” in preparation.

Distributed Partnership at a Glance
ATR NSUF & Partners—Facilities & Capabilities
University of Michigan—Ion Beam Laboratory
Team Members/Collaborato
Texas A&M University Haiyan Wang (principal investigator), Ickchan Kim, Fauzia Khatkatay, Liang Jiao, Jie Jian (Ph.D. candidates)
Idaho National Laboratory Hongbin Shang, Jian Gan (collaborators)

Radiation Stability of Ceramics for Advanced Fuel Applications

Verifying the suitability of using protons to emulate the effect of neutron-induced radiation.

Introduction

This project generated some of the first ever data on the effects of neutron irradiation on the several candidates being considered for fuel-matrix and coating materials in high-temperature gas-fueled reactors. In addition, researchers were able to make direct comparisons between neutron and proton irradiations by examining the specimens irradiated to the same dose and at the same temperature. This allowed them to verify the suitability of using protons to emulate the effects of neutron-induced radiation in ceramics at high temperature.

Project Description

The objective of this project was to examine the evolution of microstructures in proposed candidate ceramics for advanced fuels. This project utilized previously irradiated samples from the ATR NSUF Sample Library. Zirconium carbide (ZrC), titanium carbide (TiC), zirconium nitride (ZrN), and titanium nitride (TiN) were irradiated in the ATR to 1 dpa at 800° C as part of the University of Wisconsin pilot project (see Kumar Sridharan report).

The samples, comprised of 3 mm discs and 20 mm long rods, were examined using transmission electron microscopy (TEM). The goal of the TEM was to understand the effects of radiation on lattice stability, phase change, void growth, and the development of other microstructural features, such as dislocation loops and stacking fault tetrahedrals.

Post-irradiation examination (PIE) included immersion density measurements.

Accomplishments

The TEM specimens of the irradiated ceramics (ZrC, ZrN, TiC, and TiN) were prepared using the facilities at the University of Wisconsin – Madison. The irradiated microstructures were examined for the diffraction contrast images and associated diffraction patterns. The details of the irradiated microstructures were systematically studied using high-resolution phase images. Researchers observed that the irradiated microstructures of the ZrC, ZrN and TiC are decorated with a high density of dislocation loops, while the

irradiated microstructure of TiN is relatively complex, containing dislocation loops, disassociated dislocation loops and possibly nano-sized stacking fault tetrahedrals.

The faulted loops in ZrC, ZrN and TiC were confirmed by the presence of rel-rod streaks in the diffraction pattern near the zone axis of [011]. These observed microstructural defects are consistent with those found in the compounds' proton-irradiated counterparts (Figure 1), which demonstrates the similarity of the microstructural evolutions of the neutron-irradiated ZrC and the proton-irradiated ZrC under identical conditions.

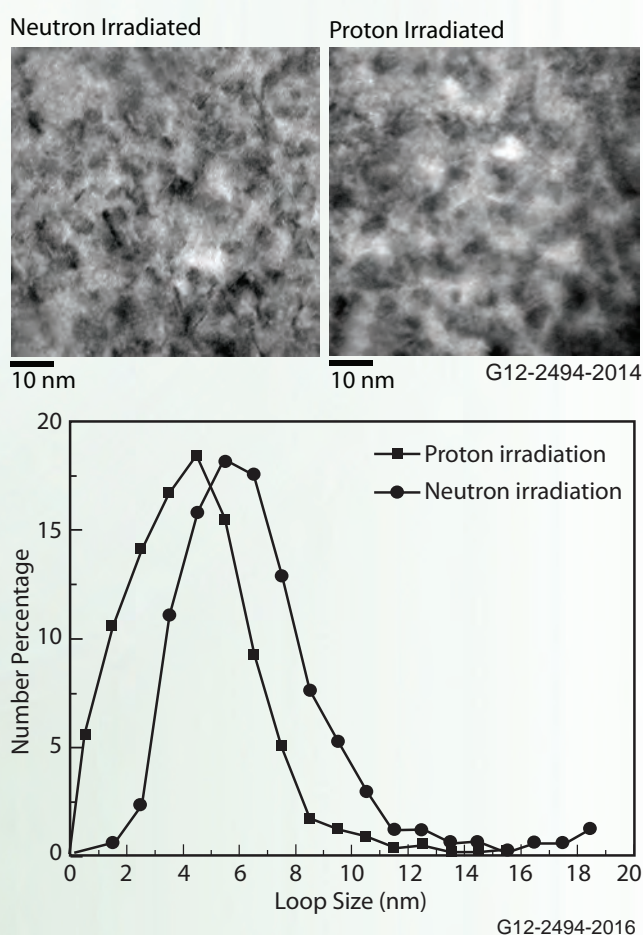

Figure 1. Comparison between ZrC neutron- and proton-irradiated to 1dpa at 800°C.

For ZrN, both the neutron- and proton-irradiated specimens showed the pronounced Moiré fringes associated with these defects. Further quantifications on the size and density of the dislocation loops in irradiated ceramics showed that the dislocation loops in the neutron-irradiated specimen were slightly larger than those in ZrC (6.6 nm vs. 5.8 nm), while the number density is

“The low-dose neutron irradiation from the Advanced Test Reactor offers a valuable opportunity to benchmark the accelerator-driven, ion-irradiation experiments performed daily on the university campus.”
 Yong Yang, Assistant Professor, Materials Science, University of Florida

slightly lower. These subtle differences might be the product of variations in the TEM-examined areas of the specimen as well as the fluctuations in the irradiation temperature.

Future activities

The project was completed in September 2011. Therefore, no further research is scheduled for the foreseeable future.

Publications and Presentations

“Radiation Stability of GFR Candidate Ceramics,” presented to TMS Annual Meeting and Exhibition, 2011, San Diego, California.

Distributed Partnership at a Glance
ATR NSUF & Partners—Facilities & Capabilities
Idaho National Laboratory —Advanced Test Reactor, PIE facilities
Team Members/Collaborators
<p>University of Florida Yong Yang (principal investigator), Clayton Dickerson (graduate student)</p> <p>Idaho National Laboratory Jian Gan (principal investigator)</p> <p>University of Wisconsin - Madison Jon McCarthy (Material Science program)</p>



iNL Idaho National Laboratory

Acronym Page Location

Click page number to go to that page

ANL	22, 23, 65, 68, 74
APS.....	8, 11, 22, 23, 74
APT	76, 92, 93, 98, 99
ATR	8, 10-12, 17, 18, 22, 24, 26, 31, 33, 42, 50, 51, 56, 58-61, 64, 66, 68, 69, 83, 84, 86, 87, 94, 96, 97
ATRC.....	42, 60, 61, 64-66
BWR.....	43
CAES	11, 60, 76, 85, 92, 93
CEA.....	64-67, 76, 77
DOE	3, 9, 10, 28, 34, 41, 44, 49, 51, 69, 82
EML.....	44, 85, 92,
FIB.....	11, 30, 37, 44, 63, 76, 77, 80, 81, 90, 92, 93
FSRT.....	52
HFEF	44, 89, 92, 93, 96, 97
HFIR.....	8, 28, 29, 42, 43, 70, 71
INL	2, 8-11, 13, 14, 17-19, 24, 26, 32, 34, 40, 42, 44, 51-54, 56, 58-61, 65, 67-69, 78, 80, 82-87, 89, 90, 92, 94, 96, 100
IIT	22, 23, 46, 74
IMC.....	45
IFEL.....	44
IMET.....	44
ISU	65-67
ITER	29
LEAP.....	17, 62, 63, 77, 92
LANL	74, 92
LWR.....	25, 43, 58, 68, 70, 71, 88, 89, 100
MaCS.....	11, 77
MFC	9, 10, 34, 56, 57, 69, 78, 85, 94



MIBL.....	46, 47, 62, 63
MIT	24, 25, 42, 43, 71, 72, 88, 89
MITR	25, 43, 70, 73, 88, 89
MRCAT	8, 22, 23, 46, 48, 49, 74
NCSU.....	17, 18, 26, 43, 44, 78
NE	10, 41, 48, 49
NIST.....	16, 44, 92
ODS	16, 62, 76, 92-94
ORNL	8, 28, 29, 42-44, 62, 63, 70, 92, 93, 98
PNNL.....	57, 71
PWR.....	5, 42, 43, 70, 72, 88
REDC	44
SANS	11, 16, 92-94
SEM	37, 79, 82, 100
TEM.....	11, 30, 35-37, 45, 57-59, 62, 63, 74, 78-82, 90-93, 96, 97, 100, 102, 103
TMS.....	103
UCSB.....	84, 87
UCB.....	45, 88
UM.....	32, 33, 45, 47, 62, 63, 76, 77, 92
UNLV	34, 45, 60, 61, 92
USU.....	56
UW	11, 16, 17, 36, 37, 45, 47, 92, 93
XAS	23, 74, 75
XRD.....	74, 75, 80